



This guide was written by the National Environmental Services Center ([www.nesc.wvu.edu](http://www.nesc.wvu.edu)) at West Virginia University on behalf of Rural Community Assistance Partnership, Inc.

Copyright © 2011

The entire contents of this guide are available on the RCAP website at [www.rcap.org](http://www.rcap.org)

This material is based upon work supported under a grant by the Utilities Programs, United States Department of Agriculture. Any opinions, findings, and conclusions or recommendations expressed in this material are solely the responsibility of the authors and do not necessarily represent the official views of the Utilities Programs.

# A Drop of Knowledge

The Non-operator's Guide to Drinking Water Systems



Rural Community Assistance Partnership, Inc.  
an equal-opportunity provider and employer  
1701 K St. NW, Suite 700  
Washington, DC 20006  
202/408-1273  
800/321-7227 (toll-free)  
info@rcap.org

[www.rcap.org](http://www.rcap.org)

# Table of Contents

ABOUT THIS GUIDE	1
<hr/>	
INTRODUCTION TO DRINKING WATER SYSTEMS	
What are water systems?	3
Source water	4
<hr/>	
HOW DOES SOURCE WATER BECOME DRINKING WATER?	
Multiple-barrier approach	8
Groundwater systems from source to tap	9
Surface water systems from source to tap	13
<hr/>	
HOW DOES DRINKING WATER GET TO MY HOME?	
THE WATER DISTRIBUTION SYSTEM	30
<hr/>	
OTHER IMPORTANT THINGS	41
<hr/>	
ADDITIONAL RESOURCES	43
<hr/>	
GLOSSARY	45
<hr/>	



photos.com

# About this guide

Water is central to our everyday lives. There isn't a single human being on Earth who can do without it. Many people live without some things that most of us consider "essential," such as electricity or a telephone. If you didn't have these things for several days or weeks, there are acceptable substitutes—using candles or writing a letter. But there are very few things, if any, that you could substitute for water if you had to go without it for a while.

Consider what just one day would be like without any clean, safe water.

You wake up, stumble into the bathroom and twist the shower handle, but nothing comes out. You're dirty and groggy, and you crave the massage of hot water or maybe the jolt of a cool shower. You're unable to brush your teeth or flush the toilet.

In the kitchen, you can't brew your morning cup of coffee. You can't make oatmeal, water your plants or wash your clothes. You can't even iron your work outfit without water.

During the course of the day, you can't wash your hands or clean your car. You won't be able to re-hydrate after a tough workout. Without water, there are no ice cubes for a cool lemonade on a hot afternoon.

## Your 'hidden' consumption of water

Freshwater is a scarce resource.

Besides the many ways we directly use water every day—drinking, washing, cooking, to flush waste away, swimming—we use large amounts of water indirectly as consumers of other goods.

A way to consider your total water usage is to look at your "water footprint." This is the total volume of freshwater used to produce the goods and services you consume each day. By becoming aware of and working to reduce your water footprint, you can help reduce strain on supplies and improve freshwater conservation.

## How do you find out what your water footprint is?

The Water Footprint Network ([www.waterfootprint.org](http://www.waterfootprint.org)) has created an online calculator to help you determine your water footprint. You can plug in your personal daily habits at [www.waterfootprint.org/?page=cal/WaterFootprintCalculator](http://www.waterfootprint.org/?page=cal/WaterFootprintCalculator)

This tool also allows you to compare your water footprint to others around the world.

*(Note: The calculators on that site use the metric system for its measurements because of the international nature of its information. You may find it helpful to search for a metric conversion tools online.)*





AWWA



USDA

## What this guide is for

Most of us take our drinking water for granted. We turn on the tap, and, with very few exceptions, we have clean, safe water. While clean water is available nearly everywhere and is simple to get through a faucet in a home, what goes on behind the scenes to provide it is very complex and requires the input of many parts and people. Water is such an ordinary and everyday part of our lives, yet it requires so much to get it to us—strict health regulations, a knowledge of chemical, biological and technical processes, budgeting to run a business, and miles of infrastructure to make it convenient to get, to name just a few things.

As a leader in your community, making decisions about your community's drinking water system is probably part of your role. And it is an important role. You may be on a board or council that is the highest decision-making body for your community's water system. This means you, along with the other leaders, need to oversee all of the activities that go on in the system—not with an extensive knowledge of each activity, but at least with an awareness of what happens and what is required.

Whatever your role or capacity is, you are to be congratulated for taking an interest in your community's drinking water supply.

You may want more information about what it takes to provide the vital resource of drinking water. This guide to the operations of drinking water systems for non-technical audiences is designed to explain a typical small-community water system—from the source of the drinking water, through the treatment process, to the customer's tap—in an easy-to-understand manner.

**TIP:** As you read this guide, keep a highlighter in hand or mark pages with sticky bookmarks for parts that are relevant to your system.

### *Informed leaders make better decisions*

This guide provides an overview of all of the technical aspects of your drinking water system so you can make sound decisions as you manage the system. This guide does not provide all of the detail and expertise to make decisions about operations and processes. You are encouraged to work with your system's certified operator(s) for this purpose and consult with him or her for advanced issues.

Water systems are moving toward “sustainability” these days. This includes doing more planning, thinking about the long-term, and finding ways to be more self-reliant. In the coming years, our nation's drinking water systems will face unprecedented challenges: water shortages, aging infrastructure, an aging workforce, and lack of funding, to name the most obvious issues.

As a local leader, your own actions can set the tone for the rest of the community. Therefore, it is your responsibility to be as informed as possible about the systems and processes that convey safe drinking water to your community's residents, businesses and institutions. This guide will supply you with some meaningful information about the state of your drinking water supplies. When you have more information, you can make better decisions about current and future operations of your community's system. By reading this guide, you are becoming engaged in the process of learning more about your responsibilities and providing an essential resource in your community.

Remember, safe drinking water is up to you and your community. Be informed. Be engaged. And be a leader.

# Introduction to Drinking Water Systems

## What are water systems?

In the United States, there are approximately 155,000 public water systems. The U.S. Environmental Protection Agency (EPA) classifies these systems according to the number of people they serve, the source of their water, and whether they serve the same customers year-round or on an occasional basis. Most public water systems are owned by the municipality they serve, but they can also be owned by private companies, nonprofit corporations, or individuals.

According to EPA's definition, a public water system transports water that has been treated or otherwise made safe for human consumption through a system of pipes and other constructed conveyances to at least 15 service connections or to a destination where at least an average of 25 individuals are served at least 60 days out of the year.

The term *public water system* includes the following:

- Any collection, treatment, storage, and distribution facilities under control of the operator of such system and used primarily in connection with such system
- Any collection or pretreatment storage facilities not under such control, which are used primarily in connection with such system.

EPA has defined three types of public water systems:

- *Community water system*: A public water system that supplies water to the same population year-round.

- *Non-transient non-community water system*: A public water system that regularly supplies water to at least 25 of the *same* people at least six months per year, but not year-round. Some examples are schools, factories, office buildings, and hospitals that have their own water systems.
- *Transient non-community water system*: A public water system that serves at least 25 *different* people for 60 days or more each year. Some examples are gas stations, campgrounds, and restaurants or bars with their own water supply, where people do not remain for long periods of time.

EPA mandates that each state and tribal drinking water primacy agency (regulatory office) inspect its drinking water systems on a regular basis. These inspections are called sanitary surveys, and they are scheduled according to system type. Here is the schedule:

System type	Frequency
Non-community water system (transient and non-transient)	Every 5 years
Community water system	Every 3 years
Community water systems with outstanding performance based on prior sanitary surveys	Every 5 years

Individual state or tribal primacy agencies can inspect more often if they choose to.



## Source water

Community water systems typically get their water from one of two sources or a combination: groundwater or surface water. According to EPA, the majority of small, rural public water systems use groundwater. Large, metropolitan areas tend to use surface water.

Each of these source water supplies has unique characteristics that require different treatment procedures. Because of this, they are further categorized into three groups: groundwater, groundwater under the direct influence of surface water (GWUDI), and surface water.

### Groundwater

The majority of drinking water systems get their water from groundwater wells, but they serve smaller populations. These are typically considered small and very small systems (501 to 3,300 and 25 to 500 people, respectively, according to EPA's classification of systems).

Groundwater, which is obtained by drilling wells, is water located below the ground surface in pores and spaces in the rock. The well depths can range from about 25 feet to beyond 1,000 feet.

Because there is less contamination in groundwater and there is less potential for pollution, the list of rules that groundwater systems must comply with is shorter. The list includes:

- Safe Drinking Water Act (SDWA)
- 1986 amendments to the SDWA
- 1996 amendments to the SDWA

Some of the specific rules included in the SDWA and the amendments are:

- Ground Water Rule
- Total Coliform Rule (TCR)
- Revised Total Coliform Rule
- Lead and Copper Rule
- Revised Lead and Copper Rule
- Public Notification Rule
- Revised Public Notification Rule
- Arsenic Rule

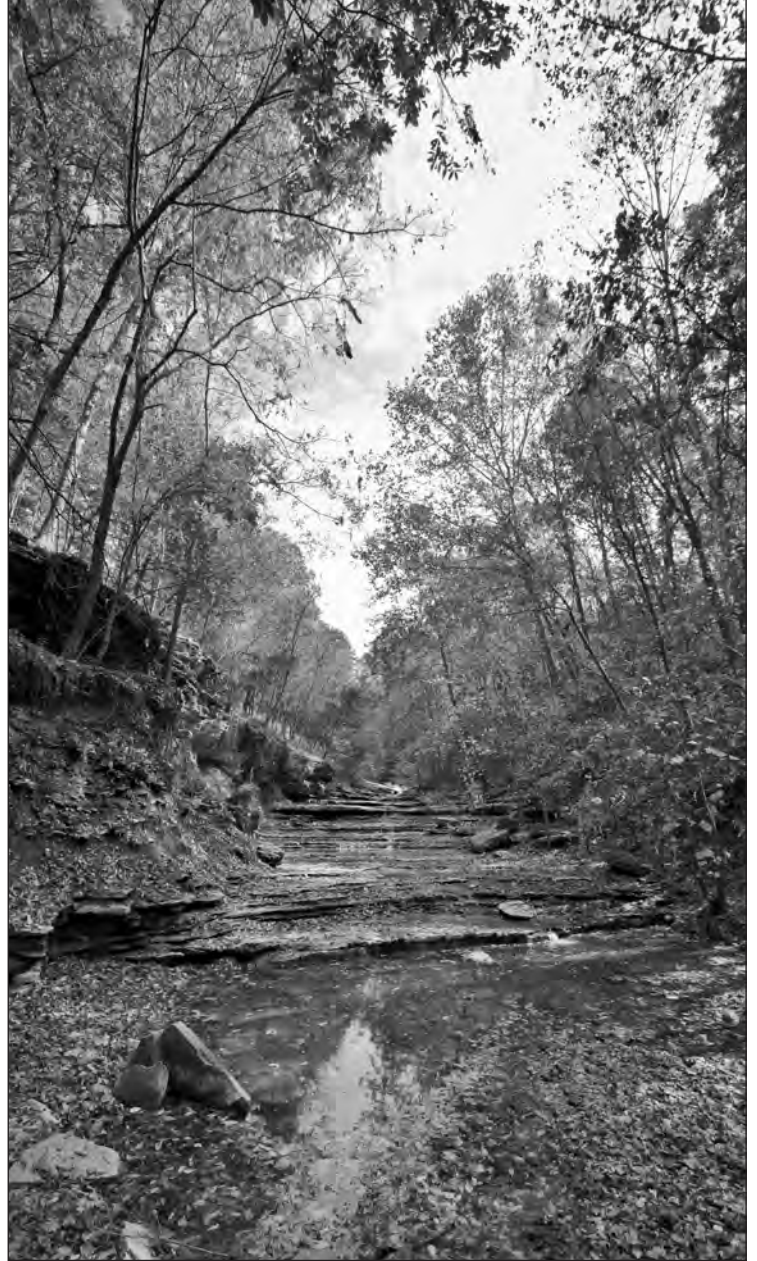

Melissa Jones, CRG



## Well-Cross Section

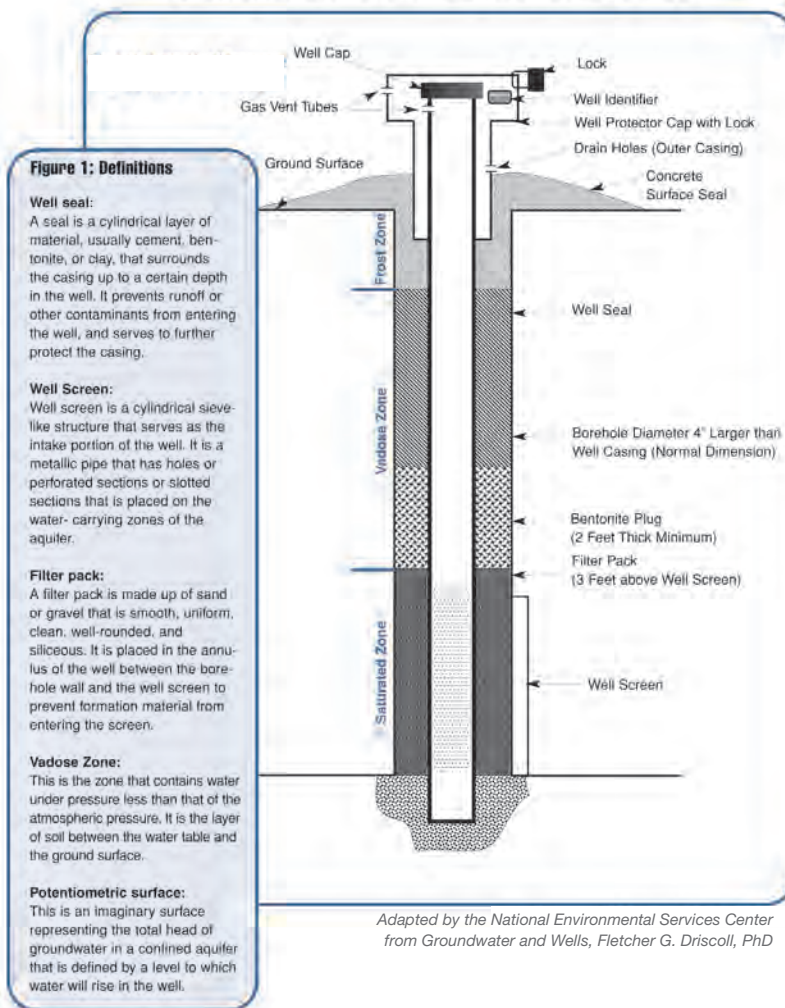

## Ground water under the direct influence of surface water (GWUDI)

A series of tests determines if a system is one with GWUDI. Required testing may vary from state to state, but it is generally based on source design and construction, an area's source water protection programs, local geology, and historical testing data.

How does groundwater come under the direct influence of surface water? The proximity of a well to a surface water source plays a major role. Also, groundwater that has no confining layer to protect it from surface water infiltration can be vulnerable.

Because some disease-causing pathogens found in surface water (e.g., *Giardia lamblia* and *Cryptosporidium*) are extremely hard to kill with conventional amounts of chlorine or ultraviolet light (UV), GWUDI sources must be treated more thoroughly than groundwater. If a source is determined to be under the direct influence of surface water, the system can either find a new source or install chlorine disinfection and filtration, in accordance with all of the Surface Water Treatment Rules.



Kay Mulligan, RCAC



## Surface water

The majority of the population uses surface water for its consumption because surface water is more abundant and easily accessible. Surface water is water that collects above ground in a stream, river, lake, reservoir, or ocean.

Surface water typically contains more contaminants than groundwater. Surface water also has a greater potential to be contaminated because it is an open water supply that is vulnerable to pollution from direct discharge of an outfall pipe or channel and storm water runoff. Direct discharges can come from industrial sources or from certain older sewer systems that overflow during wet weather. Storm water runoff becomes contaminated when rainwater washes over contaminated soil, such as agricultural operations, and either dissolves the contamination or carries contaminated soil particles along with it.

Because of these pollution concerns, surface water regulations are more stringent. For example, surface water not only requires more testing on the raw and finished water, but it also requires more monitoring during the treatment process that often must be continuous and recorded to meet federal regulations.

The federal regulations that surface water systems must abide by include:

- SDWA (also applies to groundwater)
- 1986 amendments to the SDWA
- 1996 amendments to SDWA

Some of the specific rules included in the SDWA and its amendments are:

- Surface Water Treatment Rule
- Stage 1 Disinfectants and Disinfection Byproducts Rule (DDBPR1)
- Stage 2 Disinfectants and Disinfection Byproducts Rule (DDBPR2)
- Total Coliform Rule (TCR)
- Revised Total Coliform Rule
- Public Notification Rule
- Revised Public Notification Rule
- Interim Enhanced Surface Water Treatment Rule (IESWTR)
- Long-term 1 Enhanced Surface Water Treatment Rule (LT1ESWTR)
- Long-term 2 Enhanced Surface Water Treatment Rule (LT2ESWTR)
- Lead and Copper Rule
- Revised Lead and Copper Rule
- Arsenic Rule
- If the water treatment plant has surface discharge of backwash water (after settlement), it would need the National Pollutant Discharge Elimination System (NPDES) permit through the Clean Water Act.
- State and local laws may also apply



Shutterstock



Shutterstock

### **Systems with more than one source**

Water systems sometimes have more than one source of water for capacity reasons. Perhaps one well or stream does not have the volume or capacity to supply the population. Another reason is that an area's population may fluctuate according to the season as with ski resorts or summer getaways. A third reason is that individual sources may not be suitable on their own as drinking water supplies. For instance, one source may be contaminated with high levels of fluoride, arsenic, or radionuclides, while another source may be free of such contaminants but limited in supply. Blending the water from more than one source, however, may dilute the contaminants to reduce their concentrations to below the maximum contaminant level (MCL), which is the level EPA has deemed safe. An MCL is the legal threshold limit on the amount of a substance that is allowed in public water systems under the SDWA. The limit is usually expressed as a concentration in milligrams per liter (mg/L), which is the same as parts per million (ppm), or micrograms per liter ( $\mu\text{g/L}$ ), which is the same as parts per billion (ppb) of water.

### **Purchasers**

Drinking water systems that do not treat or produce water but buy it from a water system are referred to as purchasers. Purchaser systems can also buy from other purchaser systems, which are known as consecutive purchaser systems. Purchaser systems get the finished (treated) water through one or more master meters and distribute it through their distribution systems. Even though the purchaser does not produce the water, monitoring for certain contaminants, such as disinfection byproducts, bacteria, lead, and copper, and the disinfectant residual levels, is still necessary.

# How Does Source Water Become Drinking Water?

The information in the introduction of this guide helped you to identify the characteristics of your system, including where your community gets its source water. Except in very rare cases, source water is not potable water. Once a community has established a reliable source of water, there are still many steps before raw water becomes drinking water, especially if the source is surface water. This section describes the course that water takes when it travels from the source, through the water treatment process, and finally to the tap.



Shutterstock

## MULTIPLE-BARRIER APPROACH

Water systems in the United States typically rely on a multiple-barrier approach to insure their customers have clean, safe drinking water. This approach is a system of procedures, processes, and tools that work together to prevent or reduce the contamination of drinking water from source to tap, thus reducing risks to public health.

A drinking water system has three main parts: 1) the source water (watershed/aquifer); 2) the drinking water treatment plant; and 3) the distribution system. These elements are managed in an integrated manner using procedures and tools such as:

- water-quality monitoring and management of water supplies from source to tap
- legislative and policy frameworks
- public involvement and awareness
- guidelines, standards and objectives
- research and the development of scientific and technological solutions

With the multiple-barrier approach, potential control barriers are identified along with their limitations. The barriers can be physical, such as filtration and disinfection to purify water, or they can be processes or tools that improve the overall management of a drinking water system, such as legislation that dictates EPA policies, guidelines and standards, ongoing training and education for system operators or and communication strategies that utilities can use to communicate with the media or the public.

The multiple-barrier approach also helps ensure the long-term sustainability of water supplies. Through wellhead and source water protection programs, the multiple-barrier approach can prevent water supplies from becoming contaminated—not only assuring a purer water supply, but also reducing treatment and its associated costs.

## GROUNDWATER SYSTEMS FROM SOURCE TO TAP

Groundwater is just what it sounds like: water that comes from the ground. Groundwater comes from rain, snow, sleet, and hail that soaks into the ground. The water moves down into the ground because of gravity, passing between particles of soil, sand, gravel, or rock until it reaches a depth where the ground is filled, or saturated, with water. The area that is filled with water is called the saturated zone, and the top of this zone is called the water table. The water table may be very near the ground's surface, or it may be hundreds of feet below.

Groundwater is naturally filtered to some extent when it passes through the earth to underground reservoirs called aquifers. This water typically does not contain as much organic material or microorganisms as surface water, so it requires less treatment.

Small communities often get their water from wells large enough to support their populations. Wells are typically bored

or drilled into underground aquifers to access the available groundwater. Electric submersible pumps, vertical turbine pumps, or other mechanical pumps draw the water to the surface, where it is treated and then provided to the community's residents through the distribution system.

Wells can vary greatly in depth, volume and quality. Well water may contain more minerals in solution than surface water and may require treatment to soften the water by removing minerals such as calcium, iron and manganese.

In small water systems, the role of pumping equipment is extremely critical. Because these systems are frequently constructed without back-up pumps, a single pump could fail and cause customers to be without water for an extended period of time. Additionally, small systems that use hydropneumatic tanks have very little stored water, and, therefore, a pump failure can result in customers being completely out of water within a matter of minutes.



# Groundwater Treatment Process

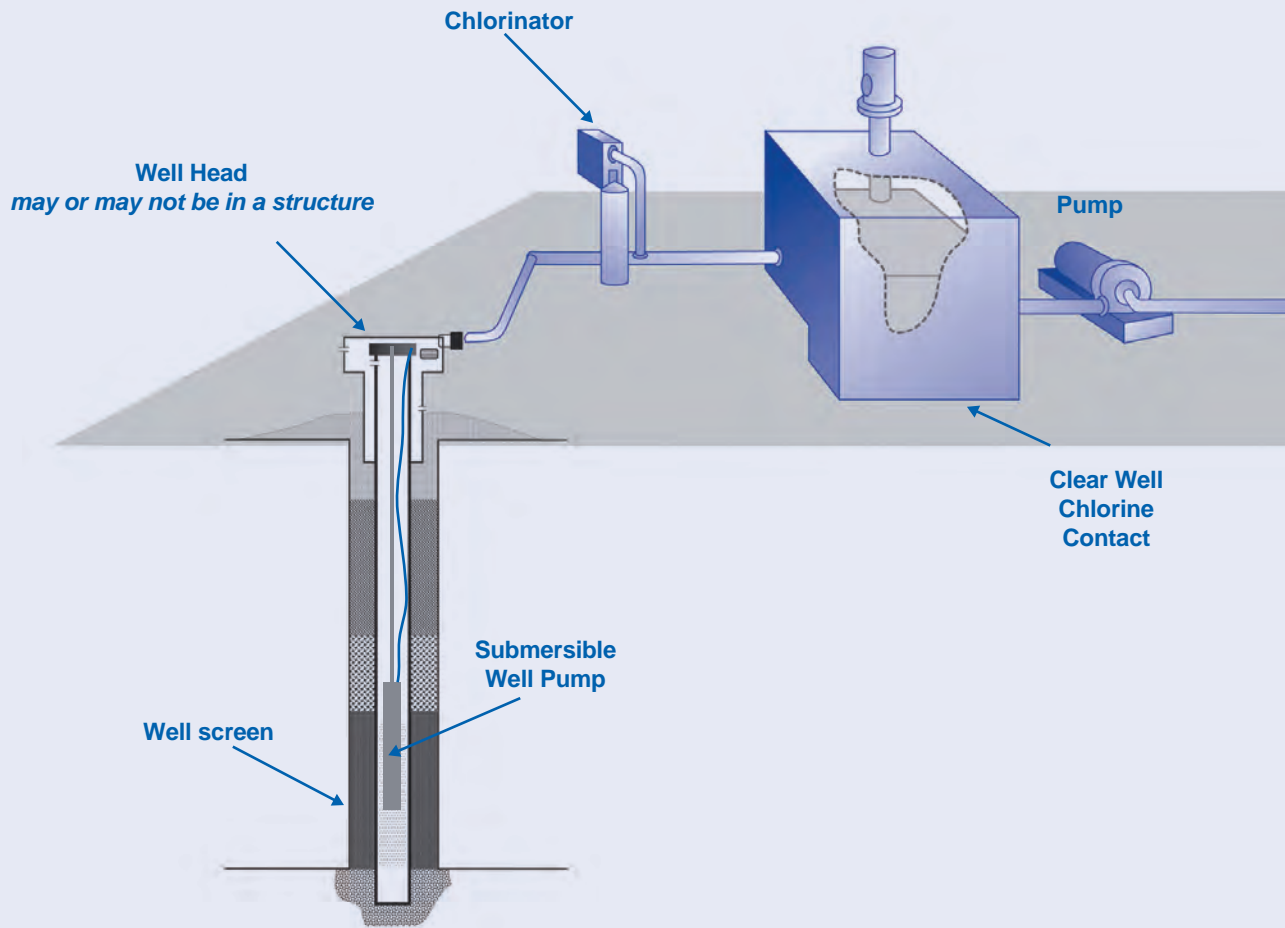

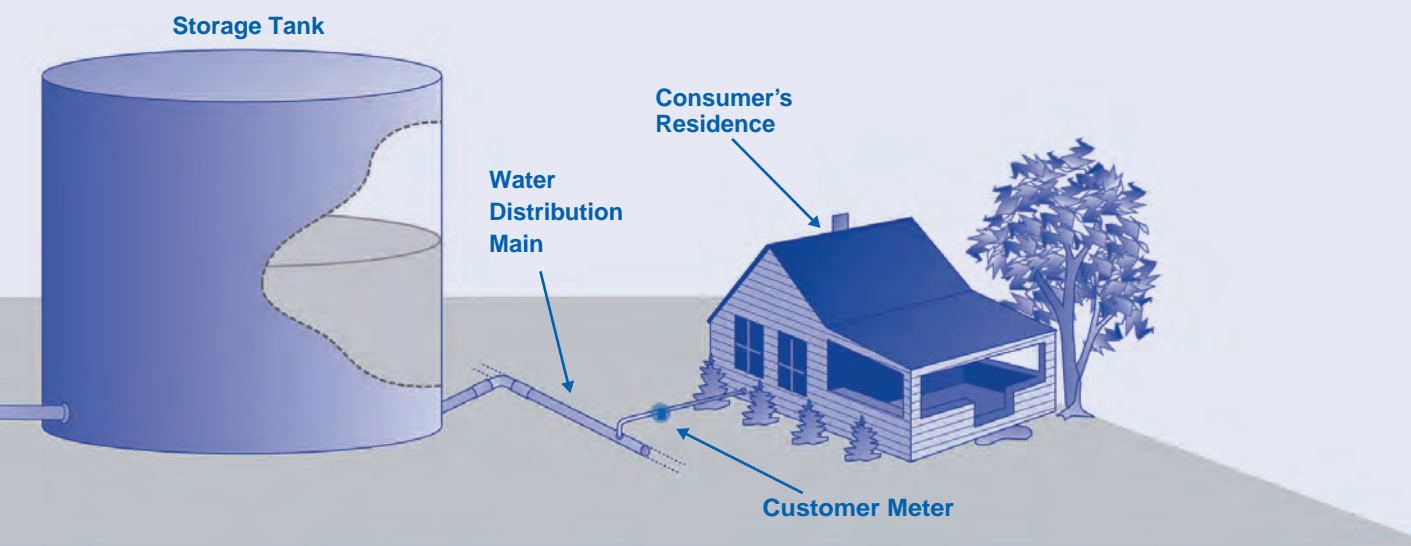

Source: National Environmental Services Center

### ***Groundwater systems with only chlorine disinfection***

Many groundwater systems require little treatment to make the water they produce safe for human consumption. These systems are not under the direct influence of surface water and continually test negative for bacteria. They also typically have little or no turbidity (cloudiness or muddiness) and test negative for contaminants. In this case, treatment usually consists of a disinfectant that is added to maintain a disinfectant residual in the distribution system. Adding a disinfectant ensures that any microorganisms that may be in the distribution system are killed before the water reaches customers. If the groundwater system serves a population of more than 3,300 (in some states this number may be less) the system must continuously monitor the disinfectant levels at the treatment plant (as it is leaving the plant).

### ***Groundwater systems with filtration and disinfection***

Turbidity, microorganisms, and chemical contaminants can all affect groundwater systems. If a groundwater system has contaminants, such as arsenic, nitrates, nitrites, or chromium, its operators must take precautions to protect the health of people who drink the water. These contaminants may be naturally occurring runoff from surrounding agricultural sites or other businesses or industries, or from sources that

cannot be pinpointed. In any case, the best available drinking water treatment technologies must be employed to remove these contaminants to meet the requirements of the SDWA.

Groundwater systems that are determined to be under the direct influence of surface water must meet all of the regulatory and treatment criteria of surface water (discussed in a later section).

### ***Distribution***

A distribution system is a system of pipes, pumps, and other conveyances that propel water to customers' taps. Most of this system is underground, leading from the water system to the consumers' taps. A more detailed explanation of distribution systems is in the chapter titled "How does drinking water get to my home?" (page 30)



# SURFACE WATER SYSTEMS FROM SOURCE TO TAP

Because it contains more contaminants, surface water is more complex to make safe to drink through the treatment process. The first challenge is getting it into the treatment plant.



Melissa Jones, CRG

## Intakes

Surface water enters the treatment facility through an intake. An intake draws raw water through a suction line that typically has a screen or other device attached to avoid drawing in fish, other wildlife, and garbage.

Intakes can be fixed in place or be adjustable to draw raw water in at different levels from the river, stream, or reservoir. This sometimes provides for a better quality or quantity of water at different times of the year. A raw water pump, located near the source water, may be used.

In some cases, drinking water systems can use gravity to get the raw water into the treatment plant. This is true if the raw water source is higher than the treatment plant.

## Pre-settlement

Pre-settlement is necessary if the raw water is very turbid or contains contaminants that need time to settle. Most drinking water systems use either earthen or concrete basins for pre-settlement. The raw water is pumped or gravity-fed to the basin. While in the basin, the water is allowed to sit so that solids can sink to the bottom of the basin. Then water that is close to the surface, usually just a few inches below the top of the basin, is pumped, or gravity is used to get the water to the next step in the treatment system.

In addition to settling water before treatment processes, pre-treatment chemicals, such as coagulants, may be used to help clarify the water.

SURFACE WATER SYSTEMS FROM SOURCE TO TAP	
▶	Intakes (A)
▶	Pre-settlement (B)
	Pre-treatment chemicals (C)
	Coagulation (D)
	Flocculation (E)
	Sedimentation (F)
	Ion exchange (G)
	Filtration (H)
	Sludge disposal (I)
	Post-treatment chemicals (J)
	Taste and odor control (K)
	Clear well (L)
	Point of use/point of entry (M)
	Testing, monitoring and reporting (N)
	Clean, safe drinking water (O)
Refer to the diagram showing these steps on pages 14-15.	

# Surface Water Treatment Process

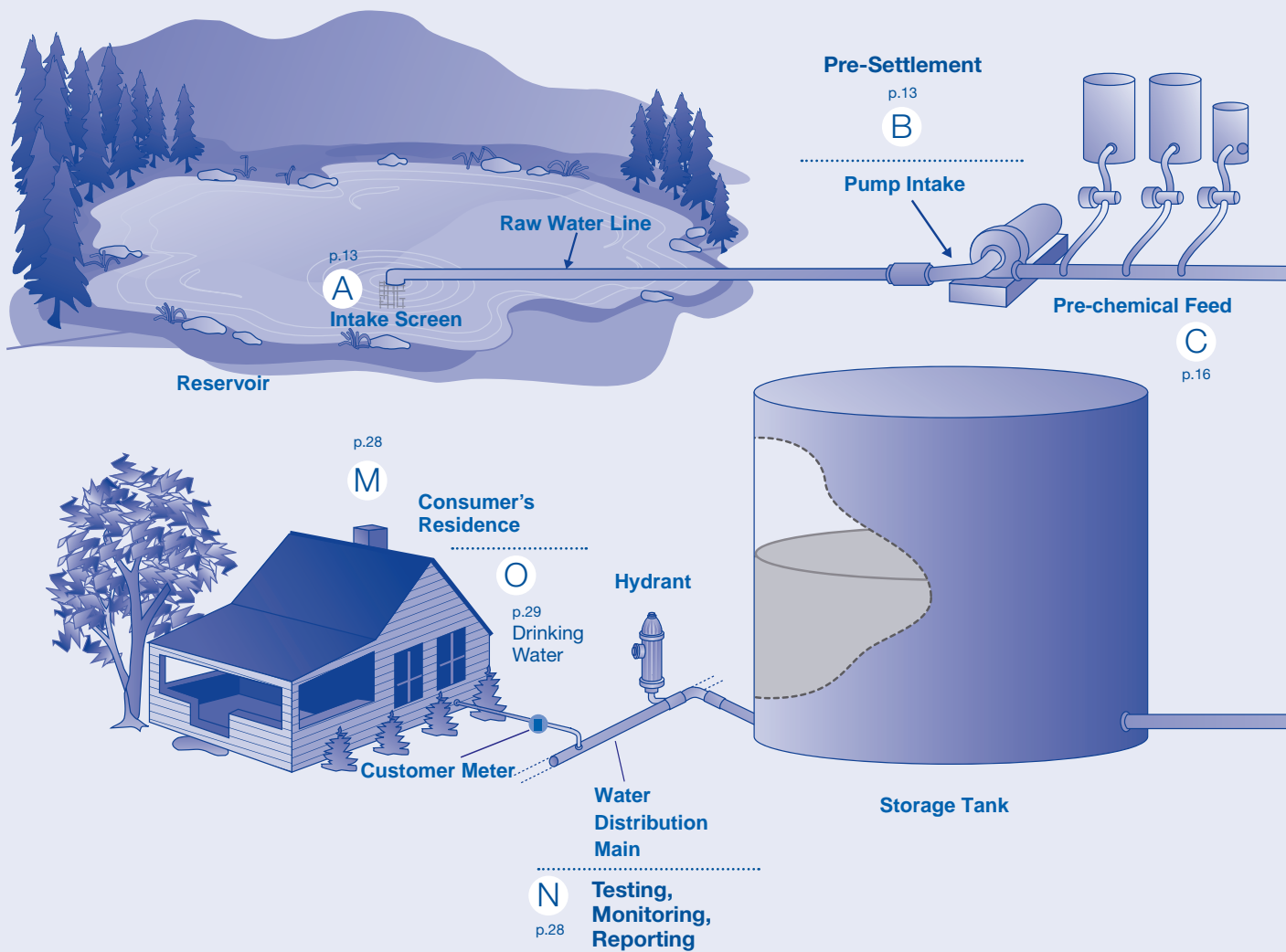

SURFACE WATER SYSTEMS  
FROM SOURCE TO TAP

Intakes (A)
Pre-settlement (B)
Pre-treatment chemicals (C)
Coagulation (D)
Flocculation (E)
Sedimentation (F)
Ion exchange (G)
Filtration (H)
Sludge disposal (I)
Post-treatment chemicals (J)
Taste and odor control (K)
Clear well (L)
Point of use/point of entry (M)
Testing, monitoring and reporting (N)
Clean, safe drinking water (O)

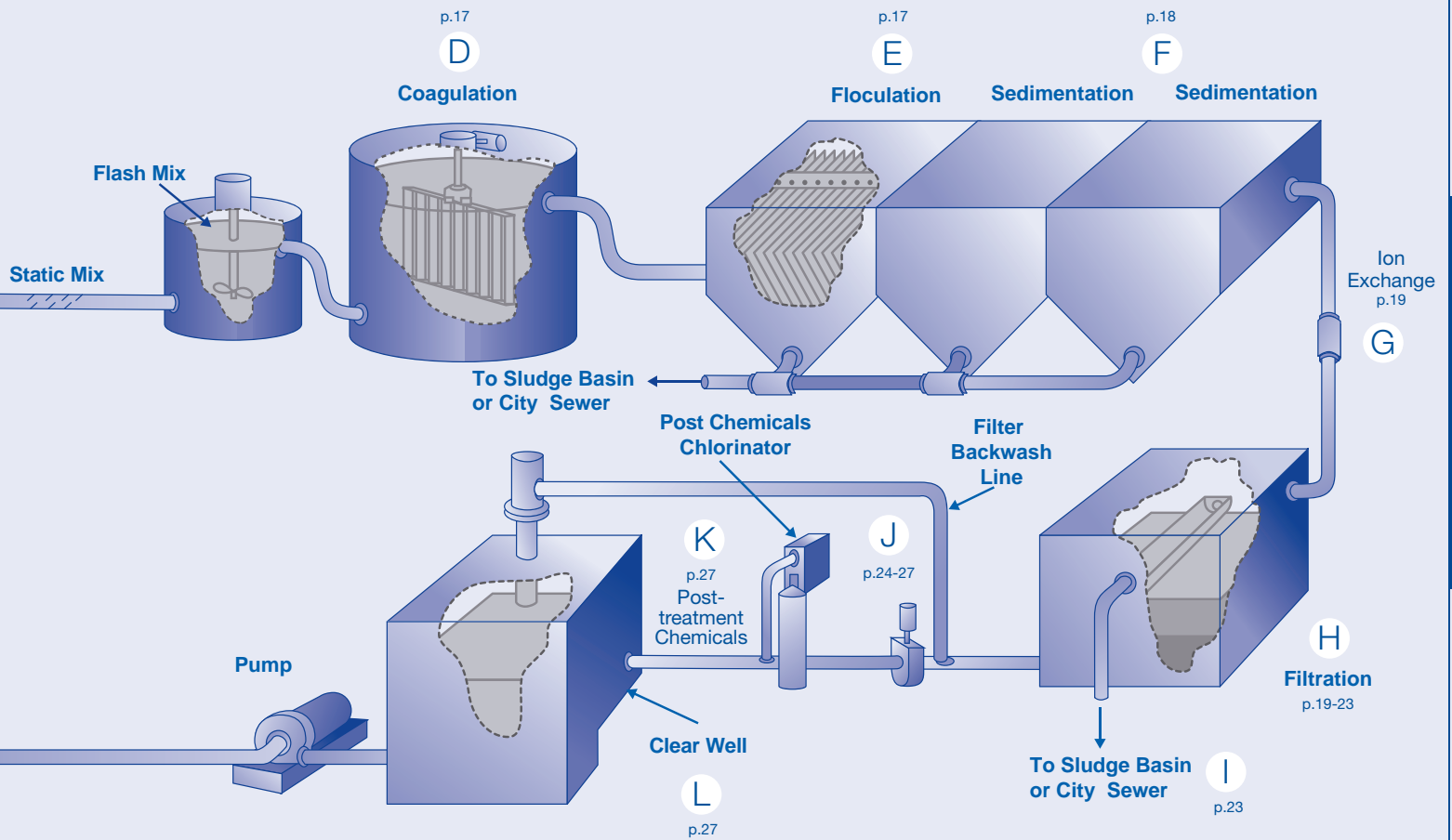

Source: National Environmental Services Center

SURFACE WATER SYSTEMS FROM SOURCE TO TAP	
Intakes (A)	
Pre-settlement (B)	
▶ Pre-treatment chemicals (C)	
▶ Coagulation (D)	
▶ Flocculation (E)	
Sedimentation (F)	
Ion exchange (G)	
Filtration (H)	
Sludge disposal (I)	
Post-treatment chemicals (J)	
Taste and odor control (K)	
Clear well (L)	
Point of use/point of entry (M)	
Testing, monitoring and reporting (N)	
Clean, safe drinking water (O)	
Refer to the diagram showing these steps on pages 14-15.	

## Pre-treatment chemicals

Adding chemicals to raw water *at or before* the start of the treatment process is called pre-treatment. Chlorine or potassium permanganate is sometimes added at the beginning of treatment to oxidize contaminants in the source water. Oxidation of organic contaminants reduces the formation of disinfection byproducts. Oxidation of certain inorganic contaminants (e.g., metals) will cause them to come out of solution and form solids that can settle or be removed by filtration. Keeping the pre-chlorine dosage low may help reduce the disinfection byproducts in the distribution system but still must be adequate to kill the bacteria that may be in the water.

If the water is acidic, the pH (a measure of acidity) can be adjusted using chemicals, such as soda ash, lime, and caustic soda, among others. Adjusting the pH helps prevent corrosion in the distribution lines and aids in the coagulation process.

Most surface water systems that deal with turbidity usually add a coagulant, a chemical that helps make dirt particles stick together so that they become heavier and settle more easily. Typical coagulant chemicals are alum (potassium aluminum sulfate or potash alum) or a polymer, such as polyaluminum chloride.

### Mixing of pre-treatment chemicals

When the pre-treatment chemicals are added, they should be thoroughly mixed with the raw water. Proper mixing of the chemicals can speed the process and even reduce the amount of chemicals used and, in the long run, save money. Static mixers or flash chambers are used for mixing pre-treatment chemicals.



## Coagulation

When the raw water and chemicals are mixed, the coagulation process begins. Coagulation chemicals cause organic and other particulates to combine. When particulates combine, they are more easily removed from the treated water because they become heavier and sink or settle to the bottom of the tank or basin. This action allows the cleaner water on the surface to move on to the next step in the treatment plant.

Although the terms *coagulation* and *flocculation* are often used interchangeably, or the single term *flocculation* is used to describe both, they are, in fact, two distinct processes. Factors that affect the coagulation process include temperature, pH, alkalinity (a measure of a solution's ability to neutralize acids), mixing of the chemicals, the type of chemical, and turbidity levels.

## Flocculation

When the coagulant is added, the smaller dirt particles stick together and form bigger particles. This is called the "floc." In the flocculation process, water flows into a tank or tanks with paddles that provide slow mixing of the coagulant chemicals. This brings small particles together to form larger particles or clumps. If the mixing is too fast, the flocs will break apart into small particles that are difficult to remove by settling or filtering.

The flocculation process can start as water leaves the flash mix chamber or tank and typically moves into a series of two or more very slow moving paddle mixers. The second paddle is sometimes slower than the first. The paddle mixers can be similar to the flash mix but at a much slower rate. A gradual stilling or calming of the water helps the floc form and keeps it from breaking apart.

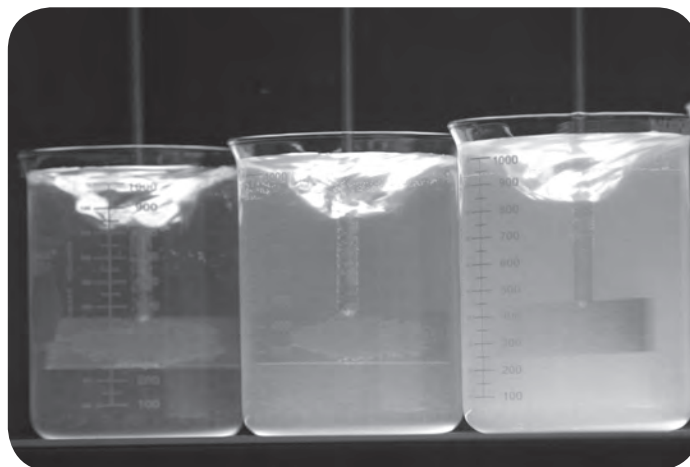

Source: National Environmental Services Center

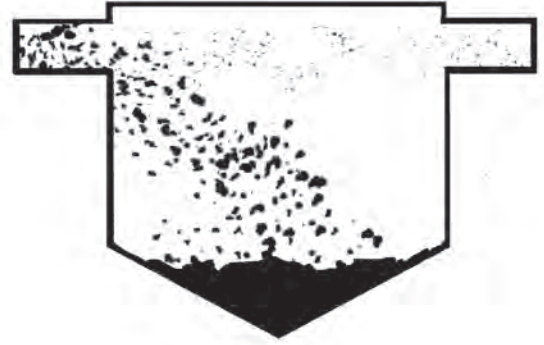

SURFACE WATER SYSTEMS FROM SOURCE TO TAP	
Intakes (A)	
Pre-settlement (B)	
Pre-treatment chemicals (C)	
Coagulation (D)	
Flocculation (E)	
▶ Sedimentation (F)	
▶ Ion exchange (G)	
Filtration (H)	
Sludge disposal (I)	
Post-treatment chemicals (J)	
Taste and odor control (K)	
Clear well (L)	
Point of use/point of entry (M)	
Testing, monitoring and reporting (N)	
Clean, safe drinking water (O)	
Refer to the diagram showing these steps on pages 14-15.	

## Sedimentation

After the dirt particles have “flocked” together, they need a place to “settle out” or sink to the bottom of the tank or basin. The key factors in good sedimentation are surface area, time, calm water, and a way to remove the sedimentation once it has sunk to the bottom of the tank or basin.

The larger the area of the tank, the calmer the water, and the more time for the process, the better the sedimentation. The tank or basin must be deep enough for the sedimentation process. Water should enter the sedimentation basin as slowly as possible. Keeping the water calm ensures that the dirt settles faster. Baffling or curtain walls can help keep the water calm. Time can be extended with baffling or curtain walls that make the flow zigzag from one end of the treatment basin to the other. If the line of flow is too straight and short, it could short-circuit the flow path. Consequently, the flocculation and sedimentation process will be disrupted.

Once the sediment sinks to the bottom of the tank, it has to be removed or it will build up and cause problems in the next step of the treatment process. Some sediment basins have cone-shaped bottoms where the sediment is collected. Others have bottoms that slope to one end or have squeegee baffles that very slowly scrape the bottom, collecting the sediment at one end.

The sediment is then pumped out into a sludge basin, or, if the water treatment plant is connected to a city sewer system, it’s pumped into the sewer system. Some plants without automated sediment collection must periodically drain the sedimentation basin and manually clean it out. Even some automated plants should be drained and cleaned occasionally.

## Ion exchange

Hard water contains high levels of minerals, such as calcium and magnesium, known as hardness ions. Hardness ions usually aren't harmful, but they can cause a number of unwanted effects in everyday life, such as soap that won't get sudsy. The biggest concerns, however, are with pumping fixtures and pipes, and the build-up of scale and corrosion, possibly leading to costly breakdowns and replacements. Ion exchange is the substitution of one ion for another and is one treatment method that can combat hard water issues. For example, if sodium chloride is added to water that is considered hard because it contains high levels of calcium, the sodium ions will exchange with calcium ions, which will help soften the water.

While ion exchange is primarily used to remove magnesium and calcium, it may also effectively remove a high percentage of barium, cadmium, chromium, silver, radium, nitratesselenium, and arsenic. In addition, ion exchange can be a good treatment choice to remove radionuclides, although these and other contaminants may result in the ion exchange reclamation water being hazardous. In such cases, disposal of the waste can be difficult and expensive.

## Direct filtration

After sedimentation, filtration is generally the next step. However, some systems use direct filtration, meaning that the raw water goes straight to the filters, bypassing coagulation, flocculation, and sedimentation. If the raw water, either groundwater or surface water, is good quality (it has low turbidity and few, if any, other contaminants, even during storm events or seasonal changes), then filtration may be the only treatment the water needs, aside from disinfection.



SURFACE WATER SYSTEMS FROM SOURCE TO TAP	
Intakes (A)	
Pre-settlement (B)	
Pre-treatment chemicals (C)	
Coagulation (D)	
Flocculation (E)	
Sedimentation (F)	
Ion exchange (G)	
► Filtration (H)	
Sludge disposal (I)	
Post-treatment chemicals (J)	
Taste and odor control (K)	
Clear well (L)	
Point of use/point of entry (M)	
Testing, monitoring and reporting (N)	
Clean, safe drinking water (O)	
Refer to the diagram showing these steps on pages 14-15.	

## Filtration

Federal and state laws require many water systems to filter their water to remove contaminants that didn't settle out during coagulation, flocculation, and sedimentation processes. Filtration simply means passing the water through a permeable fabric or a bed of porous material, such as sand, that collects, catches, or gathers suspended solids from an incoming flow. Filtration methods include slow and rapid sand filtration, pressure vessel filters, membrane filtration, cartridge filtration, bag filtration, and diatomaceous earth filtration.

When the filter's pores become clogged, they need to be cleaned. This typically involves a backwash, which is reversing the flow and increasing the speed at which water passes back through the filter. This, in effect, blasts the clogged particles off and out of the filter. Although every filter is unique, the principles of backwashing are similar for all filters except slow sand filters, in which the top few inches are periodically skimmed off.



## Types of filters

### Rapid sand filters

Rapid sand filters are the most common types of filters. These are concrete or steel boxes that contain different types and sizes of sand that are layered about three feet thick. Support gravel keeps the sand in place and acts as an underdrain for the filtered water to exit through. Rapid sand filters are most widely used to treat surface water supplies to remove turbidity and microorganisms.

### Pressure vessel filters

These filters are very similar in design to rapid sand filters. However, pressure vessel filters are entirely contained and pressurized. They may be either vertical or horizontal. When water passes through these filters, the pressure aids in moving the water quickly through the filter media, yet they effectively filter out particles.

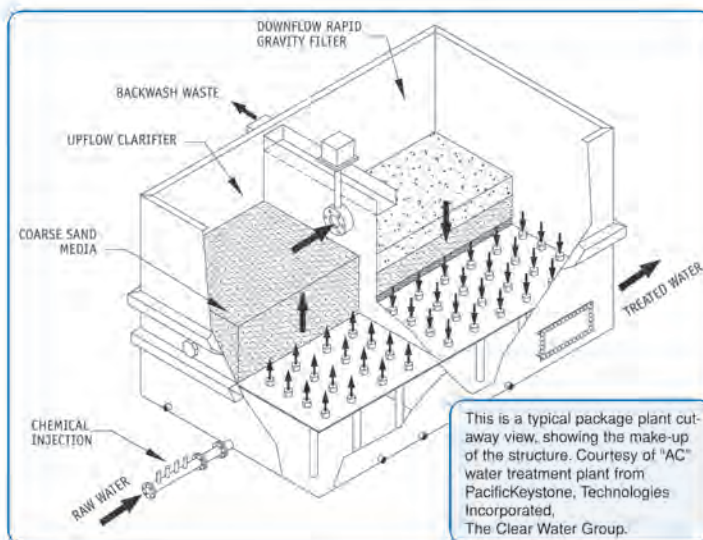
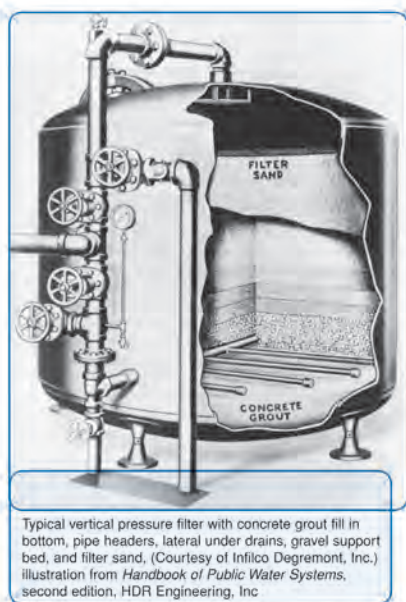

Source for all images on this page: Inflico Degremont, Inc.

## Slow sand filters

Biological processes are important for slow sand filters. In fact, for a slow sand filter to work properly, it must form a biofilm. This gelatinous layer, referred to as the *Schmutzdecke*, provides the treatment that makes the water potable. The *Schmutzdecke* contains microorganisms that trap and break down algae, bacteria, and other organic matter before the water reaches the filter medium. A slow sand filter bed consists of fine sand that is three to four feet deep and is supported by a one-foot layer of gravel and an underdrain system. Slow sand filters are simple in design, require little or no treatment chemicals, power, or replacement parts, and little operator training is necessary for them to function well. The slow rate of flow through the filter makes this type of filter less efficient for larger populations.

## Membrane filters

With membrane filters, water passes through a semi-permeable membrane, a porous material whose filtering capability is determined by the size of its pores. The pores act as a barrier to particles that are larger than the pores while water passes freely through the membrane. Membrane processes include microfiltration, ultrafiltration, nanofiltration, and reverse osmosis.

## Cartridge filters

Cartridge filters are considered for point-of-use or point-of-entry technology that is suitable for removing microbes and turbidity in small systems. Water is strained through these filters using a porous medium. They can remove particles

that measure micrometers in size, which is one-millionth of a meter (a strand of hair usually has a diameter of 20 to 180 micrometers; red blood cells are approximately 8 micrometers in diameter). These filters are suitable for removal of a number of different contaminants.

## Filtration Spectrum

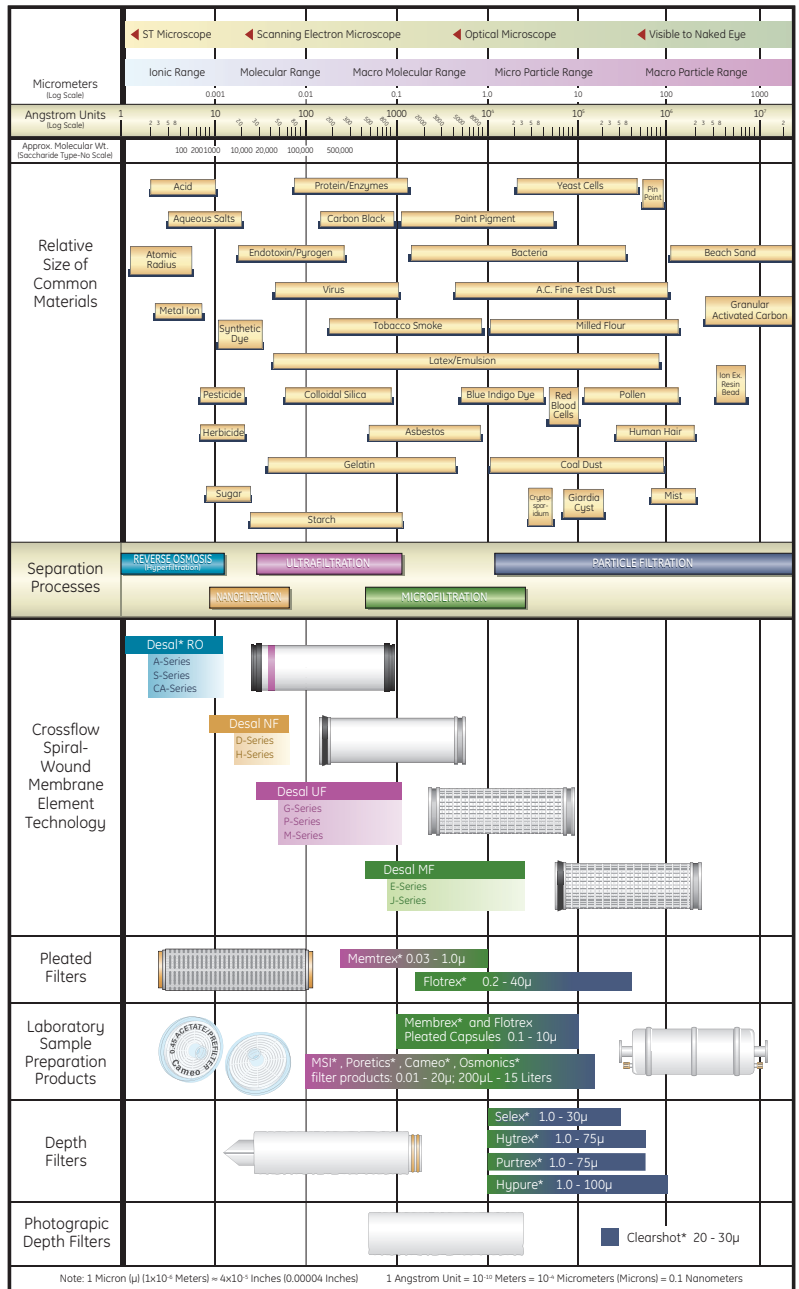

Filtration Spectrum © 2011 General Electric Co.



## Bag filters

Bag filters are very similar to cartridge filters in that an element (the bag) is doing the physical filtration and needs to be backwashed and/or replaced at regular intervals, depending on the source water. Some, if not all, states require pilot testing with the source water before bag filters or cartridge filters are used. Bag and cartridge filters are usually for low flows.

## Diatomaceous earth filters

Diatomaceous earth filtration is a process that uses diatoms or diatomaceous earth—the skeletal remains of small, single-celled organisms—as the filter media. This type of filtration relies on a layer of diatomaceous earth approximately 1/8-inch thick placed on a filter element. This method is frequently referred to as pre-coat filtration. This media may be placed in pressure vessels or operated under a vacuum in open vessels. Diatomaceous earth filters are simple to operate and are effective in removing spores, algae and asbestos from water. Some microorganisms can assume a dormant form that enables them to survive high temperatures, dryness, and lack of nourishment for long periods of time. Under proper conditions, the microorganisms may revert to their actively multiplying form.

## Sludge disposal

Most surface water systems and some groundwater systems have to deal with sludge disposal. The sludge comes from all of the particulates that settle in the sedimentation basins and are caught from the filters when backwashed.

Backwash recycling is an option that can come in handy in times of need, such as a drought. Recycling backwash water is often a standard procedure, and

SURFACE WATER SYSTEMS FROM SOURCE TO TAP	
Intakes (A)	
Pre-settlement (B)	
Pre-treatment chemicals (C)	
Coagulation (D)	
Flocculation (E)	
Sedimentation (F)	
Ion exchange (G)	
► Filtration (H)	
► Sludge disposal (I)	
Post-treatment chemicals (J)	
Taste and odor control (K)	
Clear well (L)	
Point of use/point of entry (M)	
Testing, monitoring and reporting (N)	
Clean, safe drinking water (O)	
Refer to the diagram showing these steps on pages 14-15.	

some states require systems to recycle it. Recycling backwash water involves using a separate basin or basins that can hold the volume of several backwashes to settle out solids and transferring the water back to the head of the plant to be run through the treatment processes again.

Keep in mind that the Filter Backwash Recycling Rule includes a provision that no more than 10 percent of the incoming flow can be decanted backwash water. The sludge that remains in the backwash or sludge basin after decanting will eventually have to be pumped out and either hauled to a landfill or to a sewage treatment plant for proper disposal. Most states do not allow land application of sludge from a drinking water plant because of possible heavy metals and other concentrated contaminants.

SURFACE WATER SYSTEMS FROM SOURCE TO TAP	
Intakes (A)	
Pre-settlement (B)	
Pre-treatment chemicals (C)	
Coagulation (D)	
Flocculation (E)	
Sedimentation (F)	
Ion exchange (G)	
Filtration (H)	
Sludge disposal (I)	
▶ Post-treatment chemicals (J)	
Taste and odor control (K)	
Clear well (L)	
Point of use/point of entry (M)	
Testing, monitoring and reporting (N)	
Clean, safe drinking water (O)	
Refer to the diagram showing these steps on pages 14-15.	

## Post-treatment chemicals

In addition to using chemicals early in the treatment process, there are chemicals that are added toward the end of the process. The most important of these chemical treatments is disinfection, which serves as a crucial part of the multiple-barrier approach to the provision of safe water.

### Disinfection

Whether treated water comes from a filter or is unfiltered from a groundwater source, it is disinfected as the water flows into the clear well tank. This is known as post-disinfection.

In some plants, post-disinfection may be all the disinfection that is needed. Disinfection is the process of destroying a large portion of microorganisms in drinking water with the probability that pathogenic (disease-causing) organisms are killed in the process.

### Chlorine

Chlorine is the most common chemical used for disinfection. It is typically used in either liquid (sodium hypochlorite solution or a solution made from calcium hypochlorite powder) or gaseous form. The liquid form is supplied to the water by a hypochlorination system. Hypochlorination is the most common means of disinfection for small water systems.

- **Hypochlorination feed systems**

The typical hypochlorination system consists of a chemical feed pump, a solution of sodium or calcium hypochlorite, and electrical and flow control systems.

*Hypochlorinator*

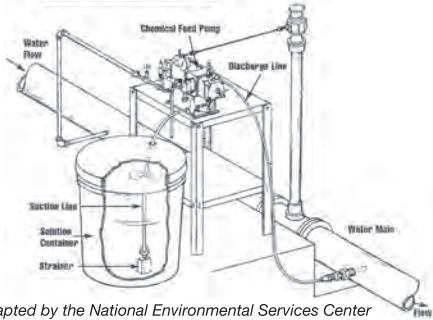

*Adapted by the National Environmental Services Center from Wallace and Tiernan Division, Pennwalt Corp.*

*Cylinder-mounted chlorinator*

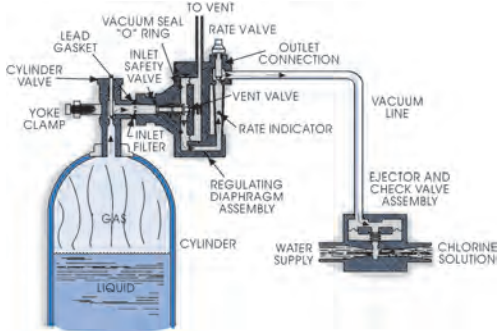

*Source: National Environmental Services Center*



- **Chlorine dosage, chlorine demand and disinfectant residual**

The total amount of chlorine fed into a volume of water by the chlorine feed equipment is referred to as dosage and is calculated in milligrams per liter (mg/L). When injected into water, it combines readily with certain inorganic substances (e.g., hydrogen sulfide, ferrous iron, nitrate, etc.) and with organic impurities, including microorganisms and nitrogen compounds (e.g., animal wastes, ammonia from fertilizers, etc.). The amount of chlorine that combines with various components of the water is called the chlorine demand. The chlorine dosage must be adequate to meet the chlorine demand and still achieve the desired disinfectant residual concentration.

- **Chlorine testing**

The kit used for chlorine testing must be EPA-approved. This can be verified by checking with your local state regulatory staff. The test kits are provided with detailed instructions on proper running of chlorine tests. It is also important to insure that all chemicals used in the testing procedure are used before the expiration date on the packages.

## Chlorine safety and handling



AWWA

Chlorine, whether in gas, solution, or powdered form, is the most dangerous chemical used at most drinking water systems. Proper storage, use, transport, and personal protection can save lives. Exposure to chlorine can lead to:

- skin burns
- lung congestion
- pulmonary edema
- pneumonia
- pleurisy
- bronchitis
- death

Chlorine gas is greenish-yellow in color. It is much heavier than air, which means it will sink to low spots—whether these are near the floor of a building or in a populated valley downhill from the treatment plant. Chlorine gas cylinders must be secured to floors or walls and labeled. Transport vehicles and the building where the chlorine is stored must be identified with signs. Plant staff working with chlorine gas must be equipped with a self-contained breathing apparatus (SCBA) with a mask that has been fitted to the user. Work with chlorine gas cylinders should be conducted only with a trained, SCBA-equipped partner standing by. In the event of a leak in the building where chlorine gas is stored or being worked with, staff in building should keep their heads high and leave the building as soon as possible.

Sodium hypochlorite solution is pale yellow in color and is very corrosive and aggravating to skin and respiratory passages. Calcium hypochlorite powder (called HTH in the water industry) is also extremely reactive. Appropriate personal protective equipment for liquid and powdered forms of chlorine includes:

- safety glasses or full-face shield
- long sleeves
- rubber gloves
- respirator (half or full-face)
- long pants
- steel-toed shoes

Plant managers should notify emergency personnel (police and firefighters) of the type and location of the disinfectant(s) used at the plant.

## SURFACE WATER SYSTEMS FROM SOURCE TO TAP

Intakes (A)
Pre-settlement (B)
Pre-treatment chemicals (C)
Coagulation (D)
Flocculation (E)
Sedimentation (F)
Ion exchange (G)
Filtration (H)
Sludge disposal (I)
▶ Post-treatment chemicals (J)
▶ Taste and odor control (K)
▶ Clear well (L)
Point of use/point of entry (M)
Testing, monitoring and reporting (N)
Clean, safe drinking water (O)
Refer to the diagram showing these steps on page 14.

### Other disinfectant and treatment measures

Other disinfectant products may be used, such as chloramines, ozone, or ultraviolet light, or additional tasks may be performed that affect water quality, such as fluoridation, pH adjustment, and the use of sequestering agents. In simple terms, to sequester a mineral or molecule is to keep it in suspension. However, the ultimate result is that the sequestered compound or molecule is made unavailable to interact with the surrounding environment.

**Chloramines** form when chlorine is added to water that contains ammonia or when ammonia is added to water that contains chlorine (hypochlorite or hypochlorous acid). Chloramines are sometimes used in low concentrations as a secondary disinfectant in municipal water distribution systems because they are much more stable than chlorine. It is also believed that chloramines are less likely to produce disinfection byproducts, such as chloroform, although there are still small amounts produced. In addition, chloramines do not have a chlorine aftertaste.

**Ozone** is a powerful oxidizing and disinfecting agent. Many municipal drinking water systems use ozone to kill bacteria instead of the more common chlorine because it has a very high oxidation potential. Ozone does not form organochlorine compounds, which are toxic, but ozone can form a toxic disinfection byproduct when the raw water contains bromine. Ozone does not remain in the water after treatment. The drinking water regulations mandate that these systems must maintain a disinfectant residual in the distribution system.

**Ultraviolet light** radiation can be used to disinfect. The ultraviolet light is generated by a special lamp. When it penetrates the cell wall of an organism, the cell's genetic material is disrupted, and the cell is unable to reproduce. As with ozone, a disinfectant residual is needed to maintain a safe barrier against any contaminants in the distribution system. Again, this residual is usually achieved with chlorine.

Another disinfectant is **chlorine dioxide**. It is a synthetic, green-yellowish gas with a chlorine-like, irritating odor and is explosive under pressure. It is difficult to transport and is usually manufactured on-site.

Ultraviolet light purifier

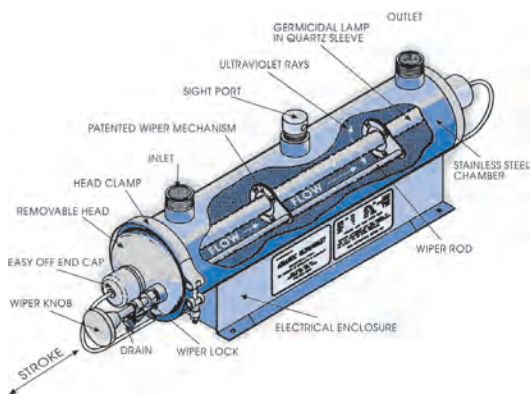

Source: National Environmental Services Center

## Disinfection byproducts

Disinfection byproducts are formed when disinfectants used in water treatment plants react with bromide and/or natural organic matter (e.g., decaying vegetation) present in the source water. Different disinfectants produce different types of disinfection byproducts. Disinfection byproducts for which drinking water regulations have been established include trihalomethanes, haloacetic acids, bromate, and chlorite.

**Trihalomethanes (THM)** are a group of four chemicals that can be formed when chlorine is used to control microbial contaminants in drinking water: chloroform, bromodichloromethane, dibromochloromethane, and bromoform. The Stage 1 Disinfectants/Disinfection Byproducts Rule regulates total trihalomethanes (TTHM) at a maximum allowable annual average level of 80 micrograms per liter ( $\mu\text{g/L}$ ), which is the same as 80 parts per billion (ppb).

**Haloacetic acids**, known as HAA5, are another group of chemicals that can be formed when chlorine is used to control microbial contaminants in drinking water. The regulated haloacetic acids are: monochloroacetic acid, dichloroacetic acid, trichloroacetic acid, monobromoacetic acid, and dibromoacetic acid. The maximum allowable annual average for the HAA5 group is 60 micrograms per liter ( $\mu\text{g/L}$ ), which is the same as 60 parts per billion (ppb).

**Bromate** is a chemical that can be formed when ozone used to disinfect drinking water reacts with naturally occurring bromide found in some source water. The maximum allowable annual average for bromate is 10 micrograms per liter ( $\mu\text{g/L}$ ), which is the same as 10 parts per billion (ppb).

**Chlorite** is a byproduct formed when chlorine dioxide is used to disinfect water. Chlorite in drinking water is regulated at a monthly average level of 1 milligram per liter ( $\text{mg/L}$ ), which is the same as 1 part per million (ppm).

## Taste and odor control

Activated carbon, although not a chemical, is used to control taste and odor problems. It is typically added in granular form to the sediment basin or on top of the filters. The contaminants are adsorbed onto the activated carbon.

Some systems add fluoride at the end of the treatment process to reduce tooth decay in their customers. Fluoridation does not affect the appearance, taste or smell of drinking water. It is normally accomplished by adding one of three compounds to the water: sodium fluoride, fluorosilicic acid, or sodium fluorosilicate. Fluoride can occur naturally in some groundwater systems, even to the extent of too much of it, which would have to be blended or reduced by membrane filtration.

Before the finished or treated water enters the distribution system, additional chemical adjustments may be needed to restore the water to a safe pH range and to prevent it from being corrosive.

## Clear well

After filtration, the water goes to a clear well, which is really just a storage tank. The clear well is usually at the plant, but at some systems, it could be the first or *only* storage tank in the distribution system. Drinking water systems use the clear well for disinfection (usually chlorine) contact time. Contact time gives the disinfectant time to kill any microorganisms that may have made it through the treatment process. Also, drinking water systems often use the clear well to store water that will be used to backwash the filters.



## SURFACE WATER SYSTEMS FROM SOURCE TO TAP

Intakes (A)
Pre-settlement (B)
Pre-treatment chemicals (C)
Coagulation (D)
Flocculation (E)
Sedimentation (F)
Ion exchange (G)
Filtration (H)
Sludge disposal (I)
Post-treatment chemicals (J)
Taste and odor control (K)
Clear well (L)
▶ Point of use/point of entry (M)
▶ Testing, monitoring and reporting (N)
▶ Clean, safe drinking water (O)
Refer to the diagram showing these steps on page 14.

## Point-of-use/Point-of-entry (POU/POE)

Some small water systems find complying with EPA's MCL requirements difficult because of the cost associated with installing large-scale treatment technologies. In these situations, POU/POE water-treatment systems in customers' homes may provide a low-cost alternative to centralized water systems, if the state rules allow them.

The 1996 SDWA lists POU/POE systems as options for compliance technologies. When a water system uses this technology to comply with a National Primary Drinking Water Regulation, the SDWA states that the public water system or a person under contract with the public water system shall own, control, and maintain the POU/ POE system to ensure proper operation, maintenance and compliance. The act also states that the treatment mechanism should be equipped with mechanical warnings that automatically notify customers of operational problems.

## Testing, monitoring and reporting

Testing and monitoring can be very costly for a small drinking water system. Despite the cost, both raw and finished water must be tested regularly. Each drinking water system is required by law to monitor and report on numerous water-quality parameters from source to tap. The monitoring is a large part of the multiple-barrier approach and is important to assure that water quality remains high and the health of the water system's customers is protected.

Monitoring plans are required by your primacy agency. A water system's monitoring plan must include:

1. system summary
2. water source details
3. water treatment details
4. distribution system details
5. individual rule (regulation) sampling plans, which meet regulations

Primacy agencies usually have monitoring plan templates available online. Schedules for sampling will be provided to the water system by the primacy agency.

Sampling plans must describe sampling sites, established test parameters and monitoring frequencies, field-monitoring protocols, and laboratory strategies. The most commonly monitored test parameters to determine the water quality in the general distribution system include coliform bacteria, heterotrophic plate count bacteria, disinfectant residual, temperature, turbidity, pH, color, and disinfection byproducts.

State and tribal agencies usually require utilities to submit their sampling and monitoring plans for approval.

### **Testing or analyzing at the plant**

The operator of a small drinking water system has many responsibilities, including collecting water samples and testing or having the water quality tested by someone else to make sure it is safe to drink and aesthetically agreeable to customers. The operator must take samples at various treatment stages to make sure that the systems are functioning properly.





Continuous monitoring devices, such as chlorine residual or turbidity analyzers, are good examples of automatic process-control testing. These automatic or inline analyzers provide continuous data to the operator about how the equipment is operating and the quality of the water being produced. These continuous monitoring devices can be expensive and are mandatory even in small systems.

## Compliance testing

Compliance testing includes checking for the 87 different contaminants on the National Primary Drinking Water Regulations list and the 15 contaminants on the National Secondary Drinking Water Regulations list. It also includes monitoring the distribution system. The national primary and secondary drinking water standards have set limits or maximum contaminant levels (MCLs). EPA sets these standards for drinking water quality.

To set an MCL for a contaminant, EPA first determines how much of the contaminant may be present with no adverse health effects. This level is called the maximum contaminant level goal (MCLG). MCLGs are non-enforceable public health goals. The legally enforced MCL is then set as close as possible to the MCLG. The MCL for a contaminant may be higher than the MCLG because of difficulties in measuring small quantities of a contaminant, a lack of available treatment technologies, or if EPA determines that the costs of treatment would outweigh the public health benefits of a lower MCL. In the last case, EPA will set the MCL to balance the cost of treatment with the public health benefits.

For some contaminants, EPA establishes a treatment technique (TT) along with an MCL. TTs are required processes intended to reduce the level of a contaminant in drinking water. An example of a TT is reducing the corrosiveness of water in order to lower the concentration of lead and copper.

Primary drinking water standards are health-based and are enforceable by law. Secondary standards are esthetic and are not enforceable.

Some contaminants may cause esthetic problems with drinking water, such as the

presence of unpleasant tastes or odors, or cosmetic problems, such as tooth discoloration. Since these contaminants do not cause health problems, there are no legally enforceable limits on their presence in drinking water. However, EPA recommends maximum levels of these contaminants in drinking water.

The amount, frequency and scheduling of tests depends on the system's population size and the detection of any contaminants. For small and very small drinking water systems, reduced monitoring for some contaminants may be granted if certain contaminants were not detected in the past, such as the four different radionuclides or lead and copper. Also some waivers can be granted for future testing if the initial required tests show the levels to be zero or below a certain limit. Reduced monitoring or waivers do not apply to all the contaminants. However, reduced monitoring waivers may be granted with a source water assessment.

The distribution system must be monitored for chlorine residual, pH, bacteria, lead and copper, and disinfection byproducts (DBPs). The DBPs test samples are taken where the water has the longest residence time, which is usually at the farthest reaches of the distribution system. These DBPs develop when chlorine is added to water that has high total organic carbon (TOC).

One way to reduce the DBPs is to reduce the TOCs or reduce the chlorine dosage at the treatment plant but still maintain safe chlorine levels to kill the microorganisms and maintain a residual in the distribution system.

## Clean, safe drinking water

Once the source water has passed through all of the steps described above, it is considered "finished" water. Now, this vital resource can be distributed to homes and businesses in your community.



AWWA

# HOW DOES DRINKING WATER GET TO MY HOME?

## THE WATER DISTRIBUTION SYSTEM

After the water has been through the treatment process, it is safe for human consumption. But until the treated water reaches the people who need it, the job isn't done. A water distribution system transports water from the treatment facility to customers' homes. The distribution system, which includes pumps, storage tanks, and miles of buried pipe, should supply adequate quantities of water that's under sufficient pressure without impairing its quality.

### Pumps

Unless the water treatment plant is located entirely uphill from the community it serves—thus making it possible for the system to supply water via gravity—it will have to pump water to its customers. Pumps are an important part of any water distribution system because they discharge pressurized water to the pipe network or lift it to places it cannot go by gravity, especially to water towers.

### Pump applications

Different tasks require different types of pumps. Pumps are selected based on a system's requirements, the required discharge pressure, the required flow capacity, and the availability of space. Three kinds of pumps are most often found in water systems:

1. centrifugal pumps to move water
2. vertical turbine pumps at intakes
3. submersible pumps in wells

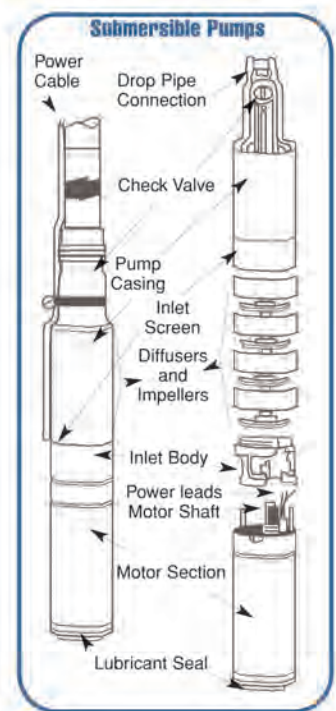
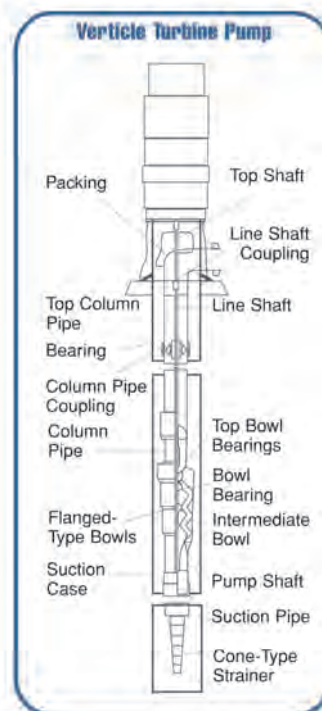
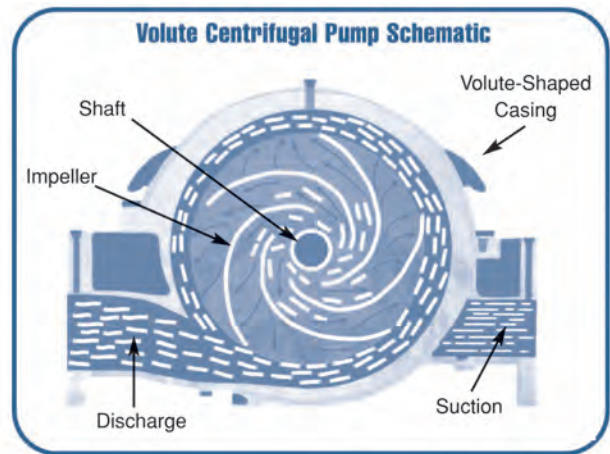

Source of all images on this page: The Aurora Pump Co.



## Storage tanks

After water leaves the treatment plant, it must be adequately and safely stored. The water distribution system should have enough storage capacity to meet all expected needs. Storage tanks:

- provide a reserve of treated water that will minimize interruptions in supply due to failures of mains, pumps, or other plant equipment
- help maintain uniform pressure
- provide a reserve of water for firefighting and other emergencies
- act as a relief valve on a system of mains supplied by pumping
- permit a reduction in the size of distribution mains below that which would be required in the absence of a reservoir
- allow pumping at the average rather than peak-flow rate

Daily use of stored water varies. Water use is greatest in the mid-morning and early-evening hours. Stored water is withdrawn during these peak demand hours of the day and is replenished during minimum-demand times in the late-night and early-morning hours.

**Hourly Water Use Variation**

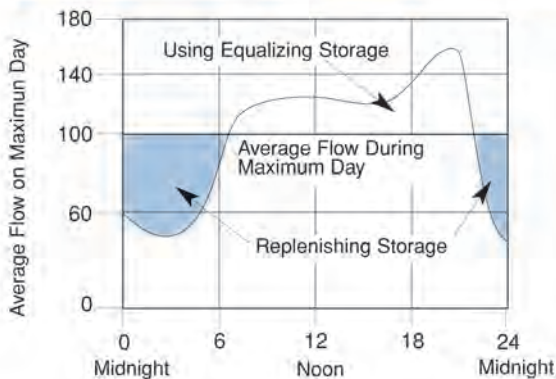

Storage tanks and water towers can be made of concrete or steel and can take various forms. The shape that is chosen is usually a compromise among function, construction

and maintenance costs, and aesthetics.

All finished water tanks must be covered to protect the stored water against contamination. Overflow pipes should be brought down near the ground surface and discharged to minimize erosion. The storage structure should be designed so that water circulates and should be properly vented.



AWWA

## Pressure tanks

Hydropneumatic tanks (or pressure tanks) are very common in small water systems that use wells to supply drinking water. The hydropneumatic system combines the energy from a pump (usually the well pump) with the principle of air pressure to force water into the distribution system. These tanks are installed between the pump and distribution system and are intended to:

- maintain an adequate and relatively even pressure in the distribution system
- reduce the number of times the well pump turns on and off

Hydropneumatic tanks are usually not large enough to provide any water storage or to supply water for firefighting. The requirements for hydropneumatic tank sizing vary from state to state, and therefore the water system operator should consult the state regulatory authority if there is a question about the adequacy of a particular tank. Because the volume of stored water is minimal, operational failures that occur with these tank systems can result in customers being completely out of water within a matter of minutes.

## Distribution line system

A drinking water system's distribution network can be made up of many different kinds of materials. The diameter of the distribution pipelines can range from as small as 3/4 inch for service lines to 6 feet or bigger for transmission or raw water lines. The materials that water lines are made of include:

- cast iron
- ductile iron
- steel (plain, galvanized and even stainless)
- polyvinyl chloride (PVC)
- high-density polyethylene (HDPE)
- reinforced concrete
- concrete truss pipe (a composite plastic and concrete)
- copper
- asbestos cement
- lead (no longer used for current water line installations but could be in use in the distribution system)
- wood—was used in very early times

The material and pipe size used in a particular system's construction depends on its peak flows, whether or not it supplies fire protection, and surge pressures that could affect the system. All pipe material and installation must meet the American Water Works Association's standards as well as state and local specifications, including depth for load bearing and frost conditions, which vary across the nation.

Once water lines have been installed, it is important to keep track of them using an accurate set of as-built drawings. "As-built" means that things change from the design stage to the construction stage because of unforeseen events, such as other underground utilities that weren't accounted for or right-of-way issues with surrounding landowners. The as-built drawings should reflect all of these changes.

Over the last 20 years, many systems have opted to put tracer wire or magnetic location tape on the pipes to make them easier to locate. When used in conjunction with an electronic pipe finder, these make the job of finding distribution lines much easier. In fact, some of these electronic locaters will work on metallic pipe without tracer wire or magnetic tape.

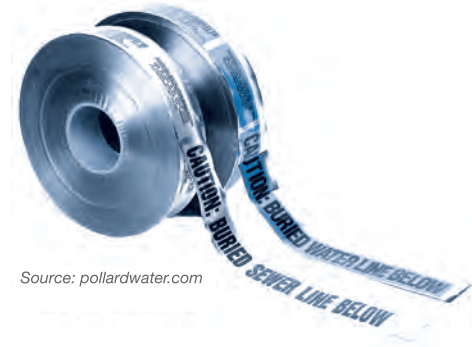

Source: pollardwater.com

### Distribution line maintenance

Maintaining the distribution system is important to keep drinking water quality at its best. Flushing the distribution system at least twice a year and line scouring every few years are two of the best ways to keep the system clean. Flushing the system helps keep sediment and biofilms down, which can affect taste and bacteria levels. The flushing should start at the source (plant, master meter) and work out in a radial pattern.

### Distribution line repair

Occasionally, water systems encounter situations in which they must repair distribution system pipes. Distribution lines can break for a variety of reasons, including excessive weight, such as increased traffic continuously running over a buried pipe. Extremely cold temperatures can also cause breaks because when water freezes, it expands. But environmental conditions are not the only reason a line may break. The pipes may split or crack because they may not have been properly installed in the trench, creating a situation where it's only a matter of time before a line bursts.



Corrosion and scaling are two more reasons that pipes can rupture. Corrosion may lead to breaks or leaks in pipes because acidic conditions can cause pitting or holes. In addition, scaling (build-up) can cause restrictions leading to high-pressure pockets in some areas of pipe.

Certain leaks may require the system to notify the state primacy agency (regulatory office), and the system may need to issue a “boil water advisory” to customers.

## Valves

Valves direct, start, stop, mix, or regulate the flow, pressure, or temperature of a fluid. Simple water faucets are considered valves, or they can be complex, such as control valves equipped with microprocessors. Many different valve types exist. However, the most common types include gate, plug, ball, butterfly, check, pressure-relief, and globe valves.

Valve functions vary based on the position of the closure element in the valve. The closure position can be adjusted manually or automatically. Valves usually fall into one of three classes:

1. shut-off valves block the flow or allow it to pass
2. anti-reversal valves allow flow to travel in one direction
3. throttling valves regulate flow at a point between fully open to fully closed

## Fire hydrants

Fire hydrants are, of course, used mainly for firefighting. But they can also be used for maintenance on the distribution system for flushing the lines when needed. The single most important thing about having fire hydrants is that they clearly advertise fire-protection services. Communities expect that at a moment's notice, day or night, in any weather, the hydrant will supply sufficient water to extinguish a fire. Usually fire hydrants can only be installed on 6-inch-diameter lines for proper flow. Water systems should be aware that the thread type for fire hoses varies, and it is critical that the local fire department be consulted and that the threads are consistent throughout the systems.

Dry Barrel Compression Type Hydrant

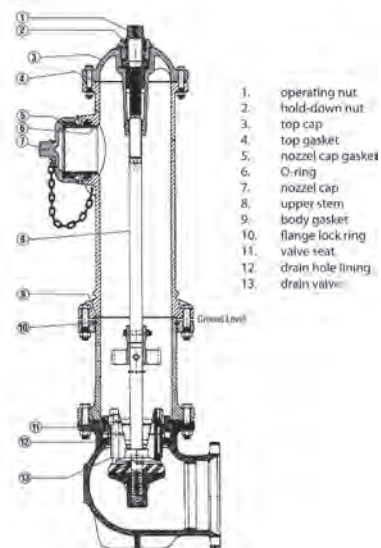

Source: [www.clowcanada.com](http://www.clowcanada.com)

CONTROL VALVES

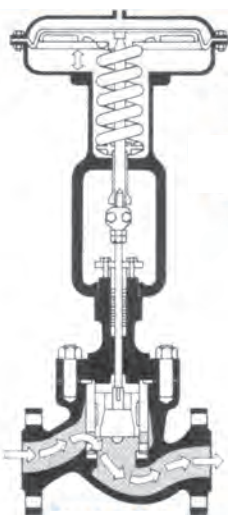

RELIEF VALVE

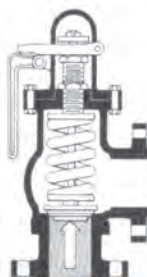

CHECK VALVES



Source: National Environmental Services Center

## Boosting pressure

In areas where there are hills or higher elevations, water pressure decreases as it moves uphill. In these cases, it is necessary to boost the pressure. Pressure is boosted using pumps housed inside a pressure-boosting station (PBS). The booster pumps are usually inline centrifugal pumps. Not all systems have or need pressure boosting.

## Reducing pressure

As water flows to lower elevations, its pressure increases. Too much pressure can rupture water lines. To avoid this situation, pressure-reducing stations (PRS) are necessary. PRSs are made up of pressure-reducing valves inside a concrete vault that are usually below grade, but they can also be in an above-grade building. The valves can be preset or manually set to reduce the water pressure. They typically last until they corrode.

## Booster disinfection

If the distribution system has many miles of pipe, the disinfectant may dissipate or react with pipe walls before reaching customers' taps. To assure the water has a disinfectant residual when it reaches the farthest tap, the water provider (whether a utility or purchaser) needs to add disinfectant. This process of booster disinfection is accomplished in a manner similar to disinfectant addition at the treatment plant.

## Meters

Any viable business must be able to determine how much of its product it is making and selling if that business is to be viable. Your water system is a business. The best way for a water utility to account for the water it produces and sells is to use meters.

Water meters are important to a utility for several reasons:

1. They make it possible to charge customers in proportion to the amount of water they use.
2. They allow the system to demonstrate accountability.
3. They are fair for all customers because they record specific usage.
4. They encourage customers to conserve water (especially compared to a flat-rate system).
5. They allow a utility to monitor the volume of finished water it puts out and compare that with the amount of water paid for by customers.
6. They aid in the detection of leaks and waterline breaks in the distribution system.

### Nutating-Disk Meter with Plastic Housing

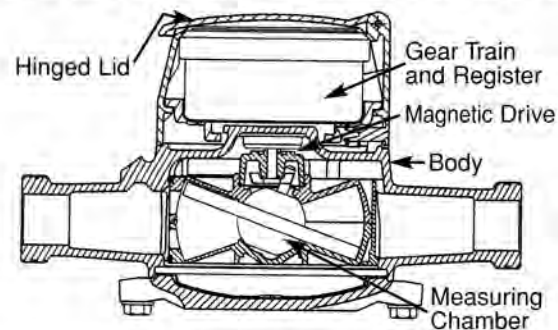

*Adapted by the National Environmental Services Center from Schlumberger Industries*

## Cross-connection control and backflow prevention

Cross-connections are points in a distribution system where chemical, biological or other contaminants can come in contact with potable water. A backflow event is when contaminants are drawn or pushed into the water system at a cross-connection. Contaminants can enter the distribution system through two mechanisms:

- backsiphonage: Contaminated water is drawn when negative or reduced pressure in the supply piping sucks non-potable fluids into the distribution system.
- backpressure: Contaminated water is pushed into a potable water system when it is connected to a non-potable system of higher pressure.

### Backflow-prevention methods and devices

There are four types of backflow prevention devices:

1. air gap
2. atmospheric vacuum breaker
3. double check valve
4. reduced pressure principle backflow preventer

Air gaps are one of the most effective ways to prevent backflow and backsiphonage. An air gap is a vertical separation between a water outlet and the highest level of a potential fluid contamination source. Air gaps should be twice the size of the supply-pipe diameter or at least one inch in length, whichever is greater.

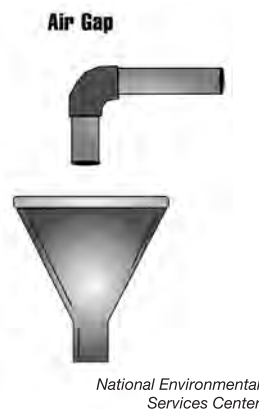

## Leak detection and water-loss control

Leaking drinking water distribution systems can cost individual utilities thousands to hundreds of thousands of dollars in repairs and lost revenue annually. Not only are utilities losing money when treated water leaks out of the distribution lines before it reaches customers, constantly leaking distribution lines will inevitably increase costs for pumping, treatment and operating a system.

Old and poorly constructed pipelines, inadequate corrosion protection, poorly maintained valves, and mechanical damage are some of the factors that contribute to leakage. Leaks not only cause water loss, but they can also reduce pressure in the system.

A leak-detection program is an opportunity to improve drinking water services. Because it is a highly visible program, it can be the first part of a water-conservation program, encouraging customers to think about water conservation before they are asked to take action to reduce their own water use.

The economic benefits of leak detection and repair can be estimated easily. For an individual leak, the amount lost in a given period of time multiplied by the retail value of that water will provide a dollar amount. Remember to factor in the costs of developing new water supplies and other hidden costs. Some other potential benefits of leak detection and repair that are difficult to quantify include:

- increased knowledge about the distribution system, which can be used, for example, to respond more quickly to emergencies and to set priorities for replacement or rehabilitation programs
- more efficient use of existing supplies and delayed expansion of a system's capacity
- improved relations with both the public and a utility's employees
- improved environmental quality
- increased firefighting capabilities
- reduced property damage, reduced legal liability, and reduced insurance because of the fewer water main breaks
- reduced risk of contamination

## Leak detection and repair strategy

There are various methods of detecting water distribution system leaks. These methods usually involve using sonic leak-detection equipment, which identifies the sound of water escaping a pipe. These devices can include pinpoint listening devices that make contact with valves and hydrants and geophones that listen directly on the ground. In addition, correlator devices can listen at two points simultaneously to pinpoint the exact location of a leak.

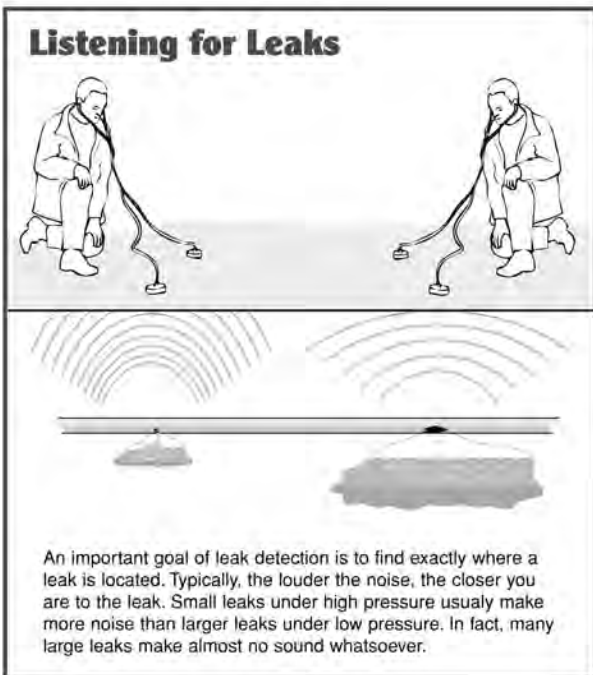

Source: National Environmental Services Center

Undetected leaks, even small ones, can lead to the loss of large quantities of water because these leaks might exist for long periods of time. Ironically, small leaks are sometimes easier to detect because they are noisier and easier to hear using hydrophones. The most difficult leaks to detect and repair are usually those under stream crossings. Leak-detection efforts should focus on the portion of the distribution system with the greatest expected problems, including areas:

- with a history of excessive leak and break rates
- where leaks and breaks can result in the heaviest property damage
- exposed to stray electric current and traffic vibration
- near stream crossings
- where loads on pipe exceed design loads

Of course, detecting leaks is only the first step. Leak repair is the more costly step in the process. Repair clamps, or collars, are the preferred method for repairing small leaks, whereas larger leaks may require replacing one or more sections of pipe. On average, the savings in water no longer lost to leakage outweigh the cost of leak detection and repair. In most systems, assuming detection is followed by repair, it is economical to completely survey the system every one to three years. Instead of repairing leaking mains, some argue it is preferable to replace more leak-prone (generally older) pipes. Selecting a strategy depends upon the frequency of leaks in a given pipe and the relative costs to replace and repair them.

Records on water production and sales

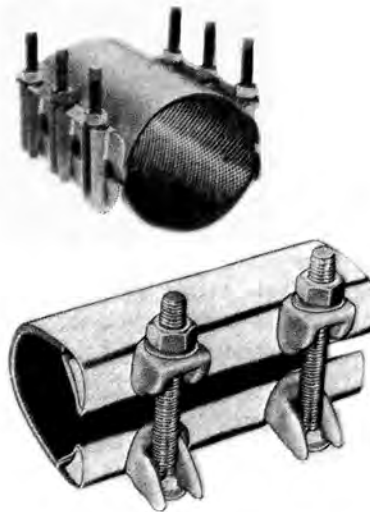

Source: Ford Meter Box Co.



and leak and break costs and benefits will become increasingly important as water costs and leak and break-damage costs increase and as leak-detection and rehabilitation programs become more important.

Three sets of records should be kept:

1. monthly reports on non-revenue water, comparing cumulative sales and production (for the last 12 months, to adjust discrepancies caused by the billing cycle)
2. leak-repair report forms
3. updated maps of the distribution system showing the location, type and class of each leak

### **Coordinating leak detection and repair with other activities**

In addition to assisting with decisions about rehabilitation and replacement, a leak-detection and repair program can further other water utility activities, including:

- inspecting hydrants and valves in a distribution system
- updating distribution system maps
- using remote sensor and telemetry technologies for ongoing monitoring and analysis of source, transmission, and distribution facilities. Remote sensors and monitoring software can alert operators to leaks, fluctuations in pressure, problems with equipment integrity, and other concerns.
- inspecting pipes, cleaning, lining, and other maintenance efforts to improve the distribution system and prevent leaks and ruptures from occurring. Utilities might also consider methods for minimizing water used in routine water system maintenance.

### **Beyond leak detection and repair**

Detecting and repairing leaks are only one water-conservation alternative. Others include:

- meter testing and repair/replacement
- rehabilitation and replacement programs
- installing flow-reducing devices
- corrosion control
- water-pricing policies that encourage conservation
- public-education programs
- pressure reduction
- requests for voluntary cutbacks or bans on certain water uses
- water recycling

### **Non-revenue Water Use**

Drinking water systems intend to sell the water they produce to their customers; water lost or siphoned from the distribution system without authorization drains system resources and revenues. Not long ago, water companies sold water at a flat rate without metering. As water has become more valuable and metering technology has improved, more and more water systems in the U.S. meter their customers. Although all customers may be metered in a given utility, a fairly sizable portion of the water most utilities produce does not pass through customer meters.

Unmetered water includes non-revenue uses, losses from accounting errors, malfunctioning distribution system controls, thefts, inaccurate meters, or leaks. Some unauthorized uses may be identifiable. When they are not, these unauthorized uses constitute non-revenue water use. Some unmetered water is taken for authorized purposes, such as firefighting and flushing and blow-offs for water-quality reasons. These quantities are usually fairly small. The primary cause of excessive unaccounted for water is often leaks.



There are different types of leaks, including service line and valve leaks, but in most cases, the largest portion of non-revenue water is lost through leaks in the mains. There are many possible causes of leaks, and often a combination of factors leads to their occurrence. The material, composition, age, and joining methods of the distribution system components can influence leak occurrence. Another related factor is the quality of the initial installation of distribution system components.

### Calculating Unaccounted-for Water

Unaccounted-for water is the difference between water produced (metered at the treatment facility) and metered use (i.e., sales plus non-revenue producing metered water). Unaccounted-for water can be expressed in millions of gallons per day (mgd) but is usually discussed as a percentage of water production:

$$\text{Unaccounted-for water (\%)} = \frac{(\text{Production} - \text{metered use}) \times 100\%}{(\text{Production})}$$

Source: National Environmental Services Center

## Water quality in the distribution system

A drinking water system's water quality may be acceptable when the water leaves the treatment plant. However, a variety of transformations can happen after the water enters and travels through a distribution system. Water producers need to understand the causes of water-quality degradation during the distribution process because, in addition to taste and odor problems that can occur, research also suggests that degraded water quality increases the risk of gastrointestinal illnesses.

A distribution system's pipes and storage equipment constitute a complex network of uncontrolled physical, chemical, and biological reactors that can produce significant variations in water quality. The principal factors that affect water degradation during distribution are the system's structure, its operation, and a number of water-quality factors.

Historically, water system designers tended to create oversized pipelines and storage equipment. While system designers may have been planning for future growth in a region when doing this, oversized equipment results in long detention times, loss of chlorine residual, taste and odor concerns, and other water-quality problems. Furthermore, some of the materials designers choose to install in distribution systems create favorable environments for growth of microorganisms.

In addition, microorganisms settle on pipe surfaces and produce a complex microenvironment known as biofilm. Biofilms form when organisms enter the distribution system and become trapped in slow-flow areas, line obstructions, or dead-end sections. They usually appear as a patchy mass in pipe sections or as a uniform layer along the inner walls of a storage tank. While not all biofilm is unsafe, researchers are currently unsure of its exact effect. Coliform bacteria may colonize in it, and biofilm may interfere with coliform detection. Biofilms also increase the chlorine demand of a distribution system. Biofilms may also cause taste and odor problems.

Pipe materials can cause water quality to deteriorate in other ways. Iron pipes can corrode, and lead and copper from pipe walls can dissolve. For example, unlined or exposed ferrous materials in pipelines can corrode and cause red or rusty-colored water. To avoid corrosion problems, systems are turning to plastic materials, such as polyethylene and polyvinyl chloride (PVC). Finally, contamination via cross-connections, leaky pipe joints, or pipe breaks may influence water quality. Pathogens, such as *Cryptosporidium* and *Giardia lamblia*, may enter the system through contaminated raw water, in-line reservoirs, or breaks in pipelines. A system's staff need to carefully and thoroughly perform flushing and disinfection procedures following repairs.



## Operational factors

From an operations standpoint, a network's operating conditions, such as slow water velocities, supply sources going on and off-line, and the amount of time that systems store water, greatly affect water quality. Any of these factors can cause chlorine residual to be depleted, and, thus, allow microbial growth in the network. Further, hydraulic conditions can cause sediment to deposit, accumulate, and serve as both habitat and protection from disinfectants for microbial growth. What's more, many storage facilities are kept full so that the system can be better prepared for emergency conditions. However, the long storage times result in degraded water quality.

Some of the other factors that provide optimal conditions for microorganisms to multiply include long water-detention times in tanks and pipes, adequate nutrient levels, and warm temperatures. In addition, research has shown that the level of biodegradable organic matter in the distribution system strongly affects bacterial re-growth and harbors opportunistic pathogens.

## Pathogens

A wide variety of organisms, mostly microscopic, is present in raw water, including some pathogens (i.e., organisms capable of causing disease). Pathogens found in raw water generally are bacteria, protozoans, viruses, and worms.

Because there are many different types of pathogens potentially present in raw water, most of which are hard to isolate and identify, it is impractical to monitor for all of them. Instead, samples are tested for what are referred to as "indicator" organisms whose presence indicates fecal contamination. Their presence does not necessarily indicate the presence of pathogens—only their *potential* presence. A number of different types of organisms have been used as indicators, but the most commonly used are coliform bacteria.

## Contamination prevention and control

Drinking water systems can improve water quality or prevent its deterioration in the distribution system. They can modify the system's operations and maintenance alternatives, make changes in treatment practices, and improve water-quality monitoring and modeling. Generally, systems need to find an optimal combination of these actions, which can involve trade-offs between cost, water-supply needs, and water-quality considerations.

bacteria

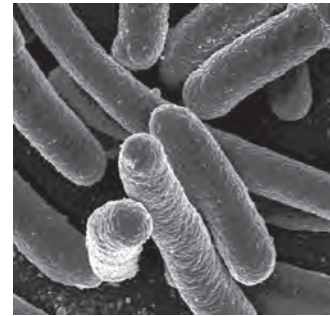

photos.com

salmonella

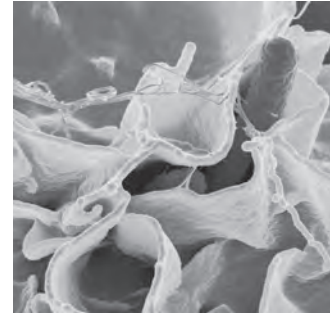

Rocky Mountain Laboratories, NIAID, NIH

*G. lamblia*

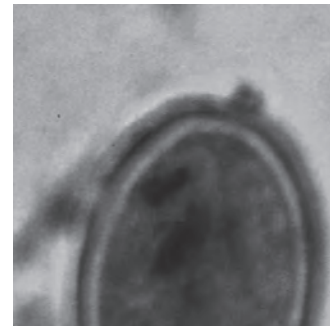

National Environmental Services Center

*E. coli* (cryptosporidium)



National Environmental Services Center

Hepatitis (virus)

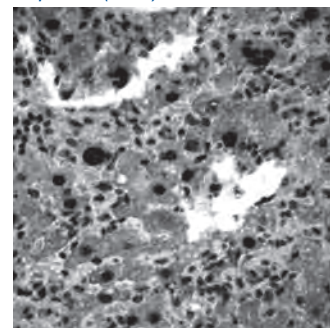

National Environmental Services Center

## Maintenance alternatives

Flushing a distribution system is an important method for keeping the water system clean and free of sediment, removing stagnant water, and removing unwanted contaminants that may have inadvertently entered the system. Drinking water systems can use a variety of pipeline-cleaning techniques. These techniques include mechanical scraping, pigging, swabbing, chemical cleaning, and flow jetting. Utility maintenance also includes emergency pipe repairs with sanitary precautions in place. Maintenance includes:

- keeping contaminated water out of the trench and pipe
- flushing the line in the vicinity of the break
- applying disinfectant to potentially contaminated components
- disinfecting new water mains
- disinfecting storage tanks after construction, inspection, or maintenance
- conducting bacteriological testing to confirm the absence of contaminants

Other maintenance activities that utilities can use to minimize water-quality degradation include:

- preventing and eliminating cross-connections
- covering and venting storage tanks
- maintaining an adequate separation from sewers
- enforcing applicable building plumbing codes

A variety of line pigs.



A pipeline prior to line pigging.



*Photos courtesy of Girard Industries*

## Monitoring in the distribution system

In addition to required monitoring for water quality, monitoring in the distribution system can involve anything from booster pump station run times to storage tank levels and security measures, such as doors and gates being opened. Operations can be monitored remotely and even controlled remotely with a supervisory control and data acquisition (SCADA) system, a centralized computer network that remotely controls and monitors an entire drinking water system. SCADA systems consist of a computer placed at a central location, communications equipment, programmable logic controllers, sensors, and other devices that, when put together, monitor and control equipment and processes in a utility.

Functions that the SCADA system can perform include: remote monitoring of well levels and control of their pumps, and monitoring flows, tank levels, or pressures in storage tanks. A SCADA system can also monitor water-quality characteristics, such as pH, turbidity, and chlorine residual, and control the addition of chemicals. In the distribution system, SCADA can supervise and control the water pressure of networks, assure water pressure is uniformly distributed, lower the leakage rate, and store data for future analysis.

SCADA is not a new technology, but significant innovations and improvements have been achieved since its introduction. Graphs and reports can be generated automatically using the data collected remotely from the field. These reports are important in looking for production and consumption patterns, data

that help manage a system's resources more efficiently. Stored information also proves invaluable when producing the annual consumer confidence reports required under the 1996 SDWA Amendments.

# OTHER IMPORTANT THINGS

Providing clean, safe water to residents is one of your community's key responsibilities. But beyond the work performed in the treatment plant and distribution network are several behind-the-scenes activities to assure that the system runs smoothly and efficiently.

## Public notification

One of the responsibilities of a water system is to communicate with customers about its water source, treatment and compliance. This is accomplished with an annual water-quality report, called a consumer confidence report (CCR). Drinking water regulations require notifying customers when certain violations occur. The regulations have established three tiers of public notification, with their urgency based on the level of risk to consumers. Required notifications may include an advisory to customers to boil their water. Water system managers should consult their state or tribal regulations regarding public notice criteria and required actions.

## Operator certification

By law, all public water systems must be overseen by a certified drinking water operator. Every operator in the United States needs continuing education units (CEUs) to maintain his or her license. The amount of CEUs required varies from state to state and with other factors, such as class of license, type of system (groundwater or surface water), and amount of treatment a system needs. Classes or training usually need to be pre-approved by the state certification office.

Because certification and continuing education are required by the SDWA, it is

## Other RCAP publications to help in the operations and oversight of water systems

If you are a board or council member or staff with responsibilities for overseeing your community's water system, the Rural Community Assistance Partnership (RCAP) has produced many other publications to assist you in these responsibilities. These publications are on the topics of:

- *A Drop of Knowledge: The Non-operator's Guide to Wastewater Systems* (companion to this guide)
- responsibilities (managerial, financial, legal, etc.) of board members of small water systems
- financial and managerial requirements for communities that are receiving U.S. Department of Agriculture-Rural Utilities Services loans and grants
- registering and reporting requirements for communities that have received American Recovery and Reinvestment Act (ARRA) loans and grants
- planning and resources for sustainable infrastructure for small water systems
- financial management of small water systems
- customer fees (setting rates, hookup fees, fines, etc.)
- developing and managing a water- or sewer-construction project
- water-distribution system maintenance
- asset management and conducting vulnerability assessments and emergency-response planning

All of the above publications can be accessed and downloaded for free (in PDF) on the RCAP website at [www.rcap.org](http://www.rcap.org) (click on "Publications & Resources" on the main menu).

### Free resources that can be sent to you regularly:

RCAP has a magazine—*Rural Matters*—that is produced every other month. Subscriptions are free. Included in each issue are articles that are useful to small community leaders and system operators. RCAP also produces an electronic newsletter, the eBulletin. Subscribing by email is also free. Each issue provides helpful tips, guides and resources on practical subjects. Find subscription information for both of these resources at [www.rcap.org](http://www.rcap.org) (click on Publications & Resources).



imperative that system managers support their operators' attendance at regular training classes as part of their work. The Rural Community Assistance Partnership (RCAP) and training centers recognized by each state and tribe can help with continuing education and certification training. (For more information about these organizations, see Additional Resources, beginning on page 43.)

During their first year, operators may be considered an operator-in-training in some states. However, every state and tribal authority is different. Check with the Association of Boards of Certification and/or the state or tribal certification office for certification information in your area.

## State and tribal primacy agencies

Every public water system which serves at least 15 service connections or serves an average of at least 25 people for at least 60 days a year is regulated by a state or tribal primacy agency (also known as the state or tribal regulator, except for the state of Wyoming, where the EPA regulates the public water systems). States and tribes vary in which branch of government is in charge of regulating the public drinking water systems. The states and tribes adopt the laws that EPA mandates for drinking water systems. In some cases, these state and tribal laws may be more stringent than the federal drinking water regulations. In return for adopting the EPA-mandated rules, the states receive federal funding.

## A drop of knowledge, but need more?

Now that you have finished reading this guide, you hopefully have a better understanding of how your water system operates. If you have questions, the best person to turn to is most likely your system's operator. As the person who ensures that your water flows every day, your operator will be knowledgeable about the processes and issues that have been described in this guide. The additional resources that are listed starting on the next page are other organizations and institutions that offer a wealth of technical assistance, publications, periodicals, and other types of help for small, rural communities.

# ADDITIONAL RESOURCES

A number of other organizations and institutions work with small communities on their drinking water and wastewater needs. Here are some of them:

## **American Water Works Association (AWWA)**

Assists communities in providing safe drinking water and works to educate people on how to operate and manage drinking water systems. A resource for information about water resource development, water and wastewater treatment technology, water storage and distribution, and utility management and operations.

(303) 794-7711

[www.awwa.org](http://www.awwa.org)

### **AWWA Small Systems section**

Resources and a helpdesk for small water systems. The site includes both technical and management assistance.

(303) 347-6191

[smallsystems@awwa.org](mailto:smallsystems@awwa.org)

[www.awwa.org](http://www.awwa.org)

(Click on Professional and Technical Resources → Small Systems)

## **Association of Boards of Certification (ABC)**

Includes almost 100 certifying authorities and represents more than 40 states. These boards certify more than 150,000 water and wastewater operators, laboratory analysts, plant maintenance technologists, bio solids land appliers, and backflow-prevention assembly testers.

(515) 232-3623

[www.abccert.org](http://www.abccert.org)

## **National Environmental Services Center (NESC)**

Assists small and rural communities with their drinking water, wastewater, environmental training, infrastructure resilience, and utility-management needs and helps them find solutions to problems they face. Provides toll-free technical assistance, training materials, publications, and free and low-cost products. Authored this guide and its companion on wastewater systems (*A Drop of Knowledge: The Non-operator's Guide to Wastewater Systems*).

(800) 624-8301

[www.nesc.wvu.edu](http://www.nesc.wvu.edu)

## **National Rural Water Association (NRWA)**

Helps states solve compliance problems. Combines both formal and classroom training with follow-up, on-site technical assistance to both member and non-member systems.

(580) 252-0629

[www.nrwa.org](http://www.nrwa.org)

## **Rural Community Assistance Partnership (RCAP)**

**National office**

(800) 321-7227

[info@rcap.org](mailto:info@rcap.org)

[www.rcap.org](http://www.rcap.org)

### **Regional partners**

See the inside back cover of this guide for contact information for RCAP's six regional partners.

These are the organizations that coordinate RCAP's work in your state and its communities.

## **[www.SmallWaterSupply.org](http://www.SmallWaterSupply.org)**

Free online resources and support for small community water and wastewater operators

## **Water-Wastewater Agency Response Network (WARN)**

A network of utilities helping other utilities to respond to and recover from emergencies. While the WARN initiative is coordinated by the American Water Works Association (AWWA), WARNs are organized on a state-by-state basis and are managed by the utilities themselves. A WARN assists water/wastewater utilities in providing mutual aid whenever a significant service interruption may require support beyond a local utility's immediately available resources. The goal is to assist in the rapid recovery of service for the protection of the public health, the environment and your local community.

<http://apps.awwa.org/EbusMain/Default.aspx?TabID=283>



## Federal government resources

The primary agencies involved in small community water and wastewater issues are:

---

### U.S. Department of Agriculture (USDA)

#### Rural Utilities Service (RUS)

(202) 720-9583

[www.usda.gov/rus](http://www.usda.gov/rus)

#### Rural Utilities Service (RUS), Water and Environmental Programs

[www.usda.gov/rus/water/index.htm](http://www.usda.gov/rus/water/index.htm)

---

### U.S. Environmental Protection Agency (EPA)

#### Office of Water

(202) 272-0167

[www.epa.gov/aboutepa/ow.html](http://www.epa.gov/aboutepa/ow.html)

#### Small Public Water Systems and Capacity Development

<http://water.epa.gov/type/drink/pws/smallsystems/index.cfm>

#### Ground Water & Drinking Water

<http://water.epa.gov/drink/index.cfm>

#### Safe Drinking Water Hotline

(800) 426-4791

<http://water.epa.gov/drink/hotline/index.cfm>

---

### U.S. Department of Health and Human Services

(877) 696-6775

[www.hhs.gov](http://www.hhs.gov)

---

### U.S. Geological Survey

(703) 648-5953

[www.usgs.gov](http://www.usgs.gov)

## Find your...

---

### State primacy agency

[www.asdwa.org/index.cfm?fuseaction=Page.viewPage&pageld=487](http://www.asdwa.org/index.cfm?fuseaction=Page.viewPage&pageld=487)

---

### State and local health departments

[www.healthguideusa.org/local\\_health\\_departments.htm](http://www.healthguideusa.org/local_health_departments.htm)

---

### State's USDA-Rural Development office

[www.rurdev.usda.gov/recd\\_map.html](http://www.rurdev.usda.gov/recd_map.html)

---

### EPA Region

<http://water.epa.gov/type/location/regions/>

---



## A

**Alkalinity** — a measure of a solution's ability to neutralize acids

**Alum** — a combination of an alkali metal, such as sodium, potassium, or ammonium, and a trivalent metal, such as aluminum, iron, or chromium. Potassium aluminum sulfate (or potash alum), the most common form, is used as a coagulant (see also **polyaluminum chloride**).

**Aquifer** — an underground layer of water-bearing permeable rock or unconsolidated materials (gravel, sand, silt, or clay) from which groundwater can be extracted

## C

**Coagulation** — a process in which a chemical is added to water to help the dirt particles stick together so that they will settle more efficiently

**Coliform bacteria** — a group of bacteria that mostly inhabits the intestinal tract of humans and animals, but also found in soil. While harmless in themselves, coliform bacteria are used as indicators of the possible presence of microbial contamination.

**Community water system** — any public water system that supplies water to the same population, when that population is at least 15 connections or at least 25 people per year

**Confined aquifer** — an underground layer of water-bearing permeable rock or unconsolidated materials bounded on top and bottom by much less permeable formations

**Consumer confidence report (CCR)** — the annual report that water systems deliver to their customers. Many utilities call this a water quality report.

## D

**Decant** — to draw off liquid without disturbing the sediment

**Disinfectants and Disinfection Byproducts Rule (DDBPR)** — the federal regulation that sets limits on disinfection byproducts in public drinking water systems

**Disinfection byproducts (DBPs)** — byproducts, such as trihalomethanes and haloacetic acids, that are formed when a chlorine disinfectant is added to raw water, especially when there are organics or total organic carbon compounds present in the raw water. Less-common DBPs include bromate, a chemical that is formed when ozone used to disinfect drinking water reacts with naturally occurring bromide found in source water; and chlorite, formed when chlorine dioxide is used to disinfect water.

## F

**Finished water** — treated water that is safe for human consumption (see also **potable water**)

**Flocculation** — a condition in which clays (dirt) or other small, charged particles become attached to each other so that they can settle to the bottom of a sedimentation basin

## G

**Ground Water Rule (GWR)** — the federal regulation for drinking water systems that use ground water as their source water

**Groundwater under the direct influence of surface water (GWUDI)** — the groundwater source is located close enough to nearby surface water, such as a river or lake, to receive direct surface-water recharge. Since a portion of the groundwater source's recharge is from surface water, the groundwater source is considered at risk of contamination from pathogens, such as *Giardia lamblia* and viruses, which are not normally found in true groundwaters.

## H

**High-density polyethylene (HDPE)** — synthetic pipe material often used in drinking water distribution systems

## I

**Interim Enhanced Surface Water Treatment Rule (IESWTR)** — the federal regulation that improves control of microbial contaminants, particularly *Cryptosporidium*, in systems using surface water and serving 10,000 or more people (see also **Surface Water Treatment Rule**)

**Inorganic compounds** — mineral-based compounds, such as metals, nitrates, and asbestos. These contaminants are naturally occurring in some water, but can also enter water through farming, chemical manufacturing, and other human activities.

## K

**Karsts** — strata in limestone deposits that have dissolved away and can create direct pathways between surface water to groundwater

## L

**Lead and Copper Rule (LCR)** — the federal regulation setting limits for lead and copper in the distribution system

**Long-term 1 Enhanced Surface Water Treatment Rule (LT1ESWTR)** — the federal regulation requiring certain public water systems to meet strengthened filtration requirements and to calculate levels of microbial inactivation to ensure that microbial protection is not jeopardized if systems make changes to comply with requirements of the Stage 1 Disinfectants and Disinfection Byproducts Rule (Stage 1-DBPR) (see also **Interim Enhanced Surface Water Treatment Rule**).

**Long-term 2 Enhanced Surface Water Treatment Rule (LT2ESWTR)** — the federal regulation designed to reduce illness linked to disease-causing microorganisms in drinking water. The rule supplements existing regulations by targeting additional *Cryptosporidium* treatment requirements in higher-risk systems. This rule also contains provisions to reduce risks from uncovered finished water reservoirs and to ensure that systems maintain



microbial protection when they take steps to decrease the formation of disinfection byproducts that result from chemical water treatment.

## M

### Maximum contaminant level

**(MCL)** — the highest level of a contaminant that is allowed in drinking water. MCLs are set as close to maximum contaminant level goals (MCLGs) as feasible using the best available treatment technology and taking cost into consideration. MCLs are enforceable standards.

### Maximum contaminant level goal

**(MCLG)** — the level of a contaminant in drinking water below which there is no known or expected risk to health. MCLGs allow for a margin of safety and are non-enforceable public health goals.

## N

### Nephelometric turbidity

**units (NTU)** — a measure of the cloudiness of water

### Non-transient non-community water system (NTNCWS)

— a public water system that regularly supplies water to at least 25 of the same people at least six months per year. Some examples are schools, factories, office buildings, and hospitals that have their own water systems.

## P

### Point-of-entry (POE)

— a treatment system for a house or a building at the point where the water line enters the house or building

**Point-of-use (POU)** — treatment at the point of use, such as a kitchen sink

**Polyaluminum chloride** — a polymer coagulant used to clump the dirt particles together for the coagulation and flocculation process (see also **Alum**)

### Poly vinyl chloride (PVC)

— a material used to make pipes for water lines

**Potable water** — water that is safe for human consumption (see also **finished water**)

### Potassium permanganate

— a chemical compound used for oxidation and taste and odor control

**Primacy agency** — the office that regulates the water systems in each state and tribe

**Primary contaminants** — also known as the National Primary Drinking Water Standards. Currently there are 87 primary contaminants (when fecal coliforms are included as a category of total coliforms). These standards are health-based and enforceable by law.

### Public water system (PWS)

— a water system providing treated water to at least 15 service connections or at least 25 people for at least 60 days a year.

## R

**Raw water** — untreated water (i.e., not safe for human consumption)

### Reduced-pressure backflow preventer

— a device used to help prevent backflow into the distribution system

## S

### Safe Drinking Water Act

**(SDWA)** — the main federal law that ensures drinking water quality. The SDWA was first enacted in 1974 and amended in 1986 and 1996. The SDWA features many actions to protect drinking water and its sources.

**SCADA** — an acronym for **Supervisory Control And Data Acquisition**, which refers to computer systems that monitor and control industrial, infrastructure, or facility-based processes.

**Schmutzdecke** — a biofilm or gelatinous layer that forms on top of a slow sand filterbed and contains microorganisms that trap and break down algae, microorganisms, and other organic matter before the water reaches the filter medium

### Surface Water Treatment Rule

— the federal regulation designed to improve public health protection through controlling microbial contaminants, particularly viruses, *Giardia*, and *Cryptosporidia* (see also **Interim Enhanced Surface Water Treatment Rule**).

### Synthetic organic compounds

— pesticides and solvents that do not evaporate at room temperature. Examples include alachlor, heptachlor, hexachlorobenzene, and 2,4 D. The main health concern is cancer. They are best removed by activated carbon.

## T

### Total Coliform Rule (TCR)

— the federal regulation for measuring the presence of coliform bacteria in drinking water. (Coliform bacteria are used as an indicator of microbial contamination.) The rule also details the type and frequency of testing that water systems must undertake. The rule applies to all public water systems.

### Total organic carbon (TOC)

— materials that come from naturally decaying plant material, such as leaves and other vegetation. TOC compounds can serve as disinfection byproduct precursors.

### Transient non-community water system (TNCWS)

— a public water system that serves at least 25 different people for 60 days or more each year. Examples include highway rest stops, gas stations, campgrounds, and restaurants.

**Turbidity** — the cloudiness of a fluid caused by individual particles (suspended solids) that scatter light. The measurement of turbidity is a key test of water quality.

## V

### Volatile organic compounds

**(VOCs)** — organic chemicals of industrial origin that evaporate at room temperature. The main health concern is cancer. They can be removed by vigorous aeration or air stripping. Examples include benzene, carbon tetrachloride, toluene, and xylene.

# Need help with your community's water or wastewater system?

The Rural Community Assistance Partnership (RCAP) is a national network of nonprofit organizations working to ensure that rural and small communities throughout the United States have access to safe drinking water and sanitary wastewater disposal. The six regional RCAPs provide a variety of programs to accomplish this goal, such as direct training and technical assistance, leveraging millions of dollars to assist communities develop and improve their water and wastewater systems.

If you are seeking assistance in your community, contact the office for the RCAP region that your state is in, according to the map below. Work in individual communities is coordinated by these regional offices.



## Rural Community Assistance Partnership

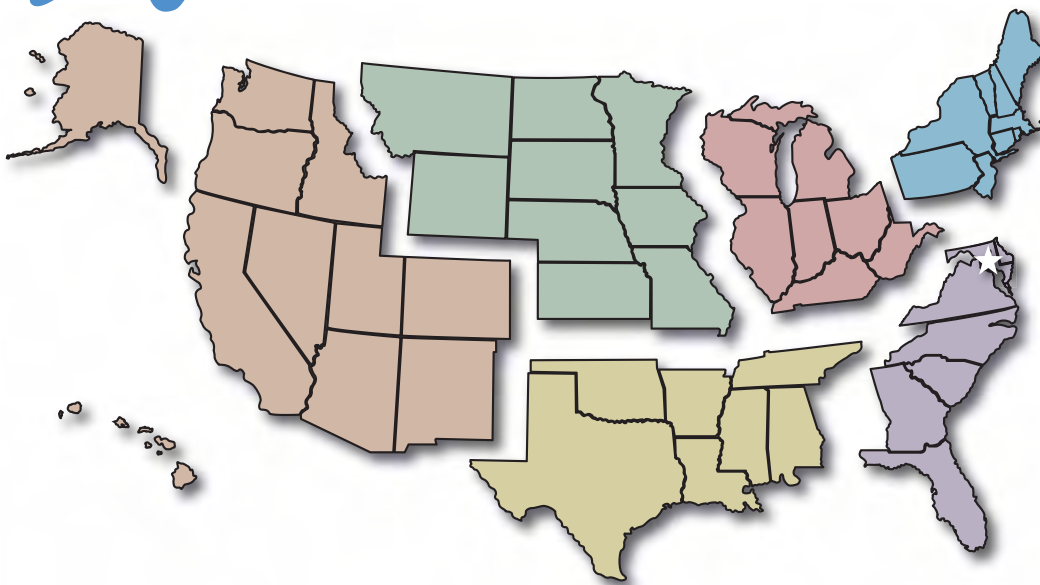

### Western RCAP

**Rural Community Assistance Corporation**  
3120 Freeboard Drive, Suite 201  
West Sacramento, CA 95691  
(916) 447-2854  
[www.rcac.org](http://www.rcac.org)

### Midwest RCAP

**Midwest Assistance Program**  
P.O. Box 81  
212 Lady Slipper Avenue NE  
New Prague, MN 56071  
(952) 758-4334  
[www.map-inc.org](http://www.map-inc.org)

### Southern RCAP

**Community Resource Group**  
3 East Colt Square Drive  
Fayetteville, AR 72703  
(479) 443-2700  
[www.crg.org](http://www.crg.org)

### Northeast RCAP

**RCAP Solutions**  
P.O. Box 159  
205 School Street  
Gardner, MA 01440  
(800) 488-1969  
[www.rcapsolutions.org](http://www.rcapsolutions.org)

Puerto Rico  
(Northeast RCAP)  
and U.S. Virgin  
Islands (RCAC)

### Great Lakes RCAP

**WSOS Community Action Commission**  
P.O. Box 590  
219 S. Front St., 2nd Floor  
Fremont, OH 43420  
(800) 775-9767  
[www.glracap.org](http://www.glracap.org)

### Southeast RCAP

**Southeast Rural Community Assistance Project**  
P.O. Box 2868  
347 Campbell Ave. SW  
Roanoke, VA 24016  
(866) 928-3731  
[www.southeastrcap.org](http://www.southeastrcap.org)

### ★ RCAP National Office ★

1701 K Street NW, Suite 700 • Washington, DC 20006  
202/408-1273 • 800/321-7227  
[www.rcap.org](http://www.rcap.org)



Rural Community Assistance Partnership, Inc.

1701 K St. NW, Suite 700

Washington, DC 20006

202/408-1273

800/321-7227 (toll-free)

info@rcap.org

[www.rcap.org](http://www.rcap.org)

Visit our website for other publications, electronic and print periodicals, and ways your community can get assistance with its water and wastewater system.